

TS

230

C3

FOUNDRY
MOULDING MACHINES
AND
PATTERN EQUIPMENT

A TREATISE

E. S. CARMAN



Class TS 230

Book .C3

Copyright N^o _____

COPYRIGHT DEPOSIT.





FOUNDRY
MOULDING MACHINES
AND
PATTERN EQUIPMENT

This ADVANCE EDITION is an abridgment of a complete book bearing this title, which is to appear in July, 1919. It is requested that published reviews be withheld, and circulation limited, remembering that this is a special "author's edition" for presentation only.

FOUNDRY
MOULDING MACHINES
AND
PATTERN EQUIPMENT

A TREATISE
SHOWING THE PROGRESS
MADE BY THE FOUNDRIES USING
MACHINE MOULDING
METHODS

▼
AUTHOR'S EDITION
ILLUSTRATED

▼
By
E. S. CARMAN
Mechanical Engineer
Mem. A S M E
Mem. C E S

▼
NEW YORK
THE NORMAN W. HENLEY PUBLISHING CO.
2 West 45th Street
1919

TS 230
C3

Copyrighted, 1919
By
E. S. CARMAN
All Rights Reserved

©

Ø

THE GARDNER PRINTING CO., CLEVELAND

©CL.A512696

MAR 10 1919

no 1

INTRODUCTION

DURING the past years marvelous advances have been made in the amount of production obtained from the daily efforts of man. This is true not only in the industrial establishments, but is true in practically all walks of life, and especially does this fact stand forth in our home life, transportation, trucking, farming, merchandising, and in the industrial arts; it is evident in the steel mills, machine shop, pattern shop, and in some few foundries, especially those foundries engaged in the manufacture of automobile castings. The increased production that is obtainable in these and many other lines of daily activities, has been brought about by the utilization and application of scientific knowledge, engineering principles and mechanical appliances.

This is a mechanical age. The hard, drudging, physical effort is being taken out of labor. Labor is now, in nearly all instances, being performed by the pulling of a lever, or the pressing of a button. The farm life is easy; plowing is performed by power, the wheelbarrow has become a truck, the Japanese jinrikisha an automobile, the hammer and chisel is replaced by a lathe and planer; but to the foundry in general these contrasts will not apply, as the moulding, in some plants, is still being performed in the same manner as it has been for centuries past. The mould is still made in the old-style wood flask, hand-rammed by the same old laborious method, and very little accomplished at the day's close. Instead of being fresh and vigorous, the man is all tired out, the production small, and in many cases the castings defective.

A new day is upon us. It is here; we cannot change it; regardless of our individual attitude, it is here to stay; we cannot even delay its workings; we must launch out into the current of modern activities or the current will strand us upon the reef. Our individual effort will be judged by the amount of work produced. There will be no place for the man who is willing to work

through a hard, long, day of drudgery in order to perform his daily work, but instead he who can produce as his day's work maximum production with a minimum of effort will be the one who stands the highest.

The manufacturer today is not desirous of obtaining a maximum production by means of exacting hard hours of labor, but instead, in the great majority of industries, the maximum production is obtained by mechanical means with minimum labor.

The foundry has been one of the last to adopt mechanical means of saving hard, drudging, labor, and the very fact of its being late in starting is perhaps the reason for the rapid development that has been made.

A further progress will have been made when more attention has been given by engineers to detail casting design in order to meet the foundry's requirements as to moulding methods, and by the manufacturer when ordering or having made the patterns that are to be used by the foundry.

It is with a view to stimulating co-operation between foundrymen, manufacturers, and engineers that this book is written. Their working together will be the means of producing the world's ever increasing casting supply in an easier and better way. The author, believing that pictures are of great value in the presentation of ideas, has endeavored, by a very liberal use of engravings, to illustrate the method of mounting patterns, and the making of moulds by machine power.



A Study in Contrasts

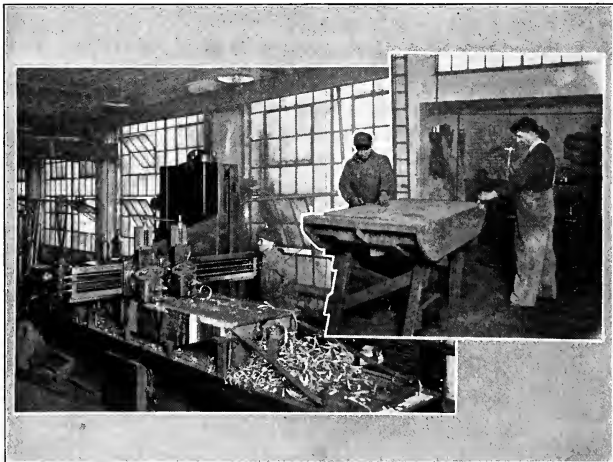

Today

Then

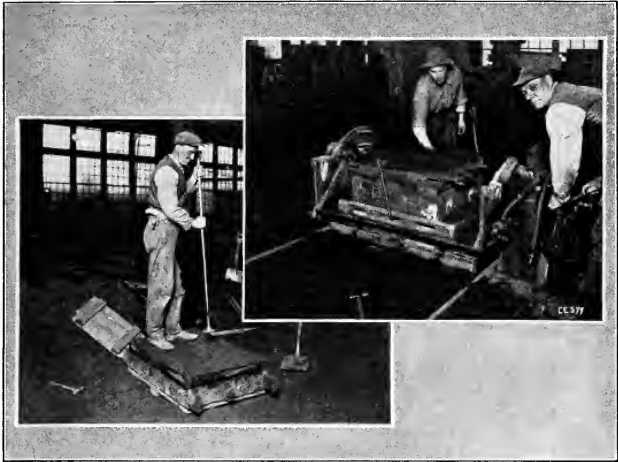

A Study in Contrasts



Today (Why?)

Today

CONTENTS

CHAPTER	PAGE
I. The Theory of Jolt-Ramming.....	1-7
Imperfections of hand rammed moulds.....	1
Jolt-ramming—how accomplished and results	1
Correct principle of jolt-ramming—with diagrams.....	4
Cushioning of the blow and its effect.....	5
Plan and sections of a well designed mould.....	7
II. The Roll-Over Jolt-Moulding Machine for Large Moulds.....	8-20
Description and operation of the machine.....	9
Illustrations and Production	{
Comparisons	{
Tunnel segment castings	12
Railway castings	14
Shipbuilding castings	15
Machine tool castings	17
III. The Roll-Over Jolt-Moulding Machine for Medium Size	
Moulds	22-46
Description and operation of the machine.....	23
Illustrations and Production	{
Comparisons	{
Automobile castings	26
Tractor castings	29
Aeroplane castings	30
Armored truck castings	31
Machine tool castings	32
Shipbuilding industry	34
Views of foundry floors	40
IV. The Roll-Over Jolt-Moulding Machine for Small Moulds.....	48-61
Description and operation of the machine.....	49
Illustrations and Production	{
Comparisons	{
Automobile castings	53
Armored truck castings	55
High pressure steam trap casting.....	57
Shipbuilding industry	58
Views of foundry floors	60
V. The Jolt-Moulding Machine in Aluminum and Brass	
Foundries	62-68
Describing and illustrating the making of Liberty motor castings.....	64
VI. Plain Jolt-Moulding Machines for Various Size Moulds.....	70-87
Description and operation	71
Illustrations and Production	{
Comparisons	{
Generator castings	78
Hydraulic machine castings	80
Railway castings	81
Miscellaneous castings	82
Views of foundry floors	87

CONTENTS

CHAPTER	PAGE
VII. Air-Operated Squeezer Moulding Machines.....	88-96
Combination jolt squeezer	89
Sand straddler squeezer	91
Description	92
Operation	92
Views of foundry floors	93
VIII. Pattern Equipment	
Important features of construction	97-115
Metal patterns and pattern-plates	98
Wood patterns and pattern-plates	100
Comparison of machine and floor patterns	102
Match-plates and vibrator frames	104
Using match-plates and vibrator frame	110
Stripping-plate patterns with stools	112
IX. Machine Moulded Cores	117-122
Bench production of small cores.....	117
Gauging and inspection of dry-sand cores.....	117
Assembling of complicated cores—assembling and setting jigs...119	
Green sand cores	120
Tunnel segment cores	122
X. Flask Equipment	123-129
Importance in machine moulding	123
Objectionable features of wood flasks.....	123
Snap flasks	124
Cast-iron flasks and bottom plates.....	125
Cut flasks	127
Rolled steel flasks	128
XI. Foundations for Jolt-Ramming Moulding Machines.....	131-143
Theory of foundation impact	132
Varying nature of soils	134
Construction	134
Accessibility to the machine	138
Illustrations of installations	139
A proposed ideal foundry design.....	142



FOUNDRY

MOULDING MACHINES

AND

PATTERN EQUIPMENT



CHAPTER I

Theory of Jolt-Ramming

Every foundryman is familiar with the skill required in producing a hand-rammed mould for the pouring of a casting. The mould, to be poured successfully, must be rammed in such a manner as will prevent swells, scabs, blowholes, etc. When such a performance is undertaken by hand-ramming, trouble is experienced in securing a mould with a surface upon which the metal is to lay, that is of uniform hardness and without the adjacent hard and soft spots, which, when the metal is poured, cause the gases to flow to the soft spots instead of entering the surface of the sand without flowing.

It is obvious that the moulder with his small tamp could not, without exceptional skill, produce a surface of even strength and texture and without initial strains in the body of the sand. The pouring of the hot metal against the sand releases the strains caused by uneven ramming by taking away the binding elements, allowing the sand to flow until it becomes of uniform hardness, sufficient to withstand the pressure of the metal. This movement of the sand is the cause of the rough, uneven surfaces that are usually seen on the castings produced by hand-rammed moulds.

In contrast with the above described hand method, the iron will lie properly and the gases enter the sand uniformly in the mould that is produced by jolt-ramming on a machine.

Jolt-ramming is accomplished by the lifting of the table, pattern, flask and sand a short distance and then allowing them to drop and contact with an anvil which stops and reverses the table, pattern and flask, but allows the sand to continue onward

in its descending course, producing a slipping action between the flask and sand, also producing a pressure on the sand lying nearest the pattern and pattern-plate. By a repeated number of machine blows the sand is caused to flow to the bottom of the mould and pack into the flask corners and around the pattern in a uni-

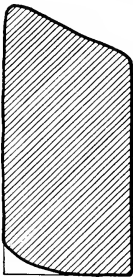

Fig. 1

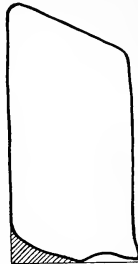

Fig. 2

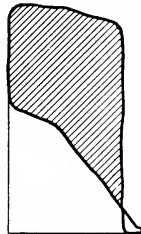
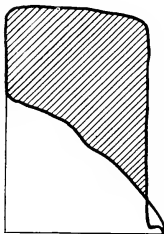

Fig. 3

form manner; the jolting action of the machine causes the grains of sand to flow in the direction of least resistance, and therefore the mould is packed in an even and uniform manner and without setting up strains between the different sections.

The development of the jolt-ramming method of moulding has produced a machine that will jolt-ram a mould complete in from 5 to 30 seconds of time, operating with a stroke of 1" to 2" in length, and at a rate of 150 to 250 strokes per minute. It

is well to point out the fact that after the mould has been properly rammed either by hand or the machine, it is many times spoiled or damaged by the moulder attempting to draw the pattern from the sand by hand; distortion of the mould takes place by rapping the pattern; this also destroys the life of the pattern,

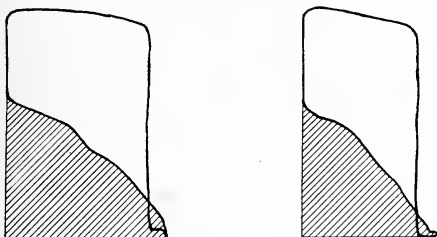

Fig. 4

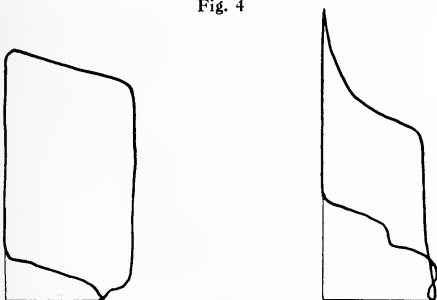

Fig. 5

which of necessity must be made of a light and fragile material.

Since the saving in time effected by means of jolt-ramming is perhaps not more than 20 to 25 per cent of the whole, it is advisable that more time be saved by having a machine that not only jolts but also rolls over the mould, and draws the pattern from the sand. These operations are being performed by machine power in from 10 to 30 seconds of time, producing a mould that has not been distorted or broken, and leaving the patterns undamaged by rapping.

It has been found that to produce a machine that will jolt-ram a mould in the manner described in the preceding paragraphs there should be no pause in the upward action of the stroke, but, on the contrary, the upward action of the stroke should start rapidly and at the instant of table contact with the anvil, in order to prevent the moving parts from coming to rest at the end of the slight rebound stroke, due to impact only. If this impact rebound is allowed to expend itself before the table again starts on its upward stroke by means of the power, the pressure on the sand is then released and instead of pressure, the sand itself rebounds and retards or destroys the packing action. Machines that do not make use of this pressure require a longer time in which to pack the sand, and indicator cards taken from such a machine would

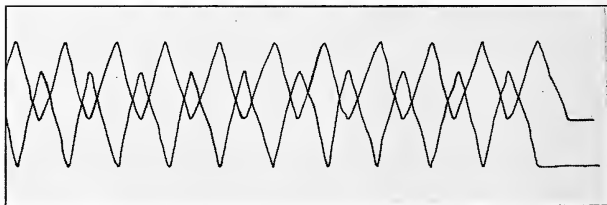

Fig. 6

be as shown in Figures 1 and 2, in which the extreme width of Figure 1 represents the pressure required to lift the table with equipment, and the extreme width of the shaded portion of Figure 2 represents the pressure at the time of contact. Since the indicator diagram Figure 2 shows that the pressure in the cylinder at the time of contact is only one-half of the amount required to lift the load, it is obvious that the moving parts will rebound and that, without sufficient pressure in the cylinder, the parts will, when the force of the rebound is spent, settle back again until sufficient air is admitted to the cylinder to obtain the pressure required to again lift the load.

The indicator cards shown in Figures 3-4 are taken from a machine having a balanced piston type valve, so constructed as to

close the exhaust after the air from the previous stroke has been exhausted, also admitting line air to the cylinder before the falling load has contacted with the anvil, resulting in the moving parts being rapidly reversed after contacting, and the sand pressure in the mould maintained during part of the upward stroke.

The width of the shaded portion of Figure 3 represents the air pressure required to lift the load; the width of the shaded portion of Figure 4 represents the pressure developed by the downward movement of the piston acting upon the air, at atmospheric pressure in the cylinder, after the exhaust is closed, and

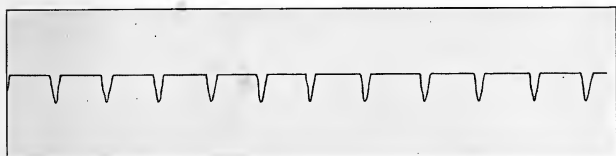

Fig. 7

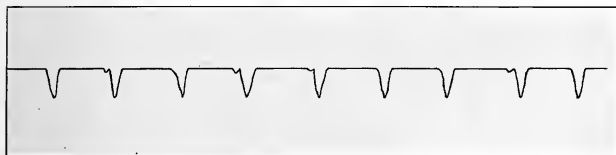

Fig. 8

also upon the admitted compressed air; the resulting pressure is from 10 to 20% higher than the pressure required to lift the load, and takes place at a point in the stroke just before contact is made and, therefore, does not appreciably lessen the speed of the falling parts but does, however, cushion the blow so that the force of the blow is not transmitted to the base and foundation, the contact being necessary to cause the reversal of the moving parts, which is sufficient to properly ram the sand; nor is there the heavy strain set up in the falling parts as would otherwise be the case if the whole load were allowed to fall with the full force of gravity. The action obtained in the moving parts is

rapid, and at the time of contact with the anvil they are resiliently reversed in their direction of travel, while the sand, being loose, continues its pressure downward without rebounding and becoming again loose in the flask.

Figures 6, 7 and 8 show a manner in which machines are tested to determine the quality of the packing action, also uniformity of stroke and valve action.

The diagram shown in Figure 6 represents a reading made by the testing of a jolt-moulding machine to ascertain the relation of the falling parts and their load, to the relation of the valve action. This style of test is also used in ascertaining the effect of compression in retarding the inertia of the falling parts.

The diagram appearing in Figure 7 represents the packing qualities of the machine and is also used to determine the uniformity of stroke.

Figure 8 discloses an irregularity of action and indicates existing trouble, which, when overcome, should produce a diagram similar to that shown in Figure 7.

Testing diagrams, such as referred to above, are a decided benefit in producing duplicate machines. Experience has shown that the stroke which produces good packing results with one grade of sand does not always produce equal results when using a different grade, and, likewise, any decided variation in pattern and flask equipment requires an alteration of stroke to produce the same results in the same length of time.

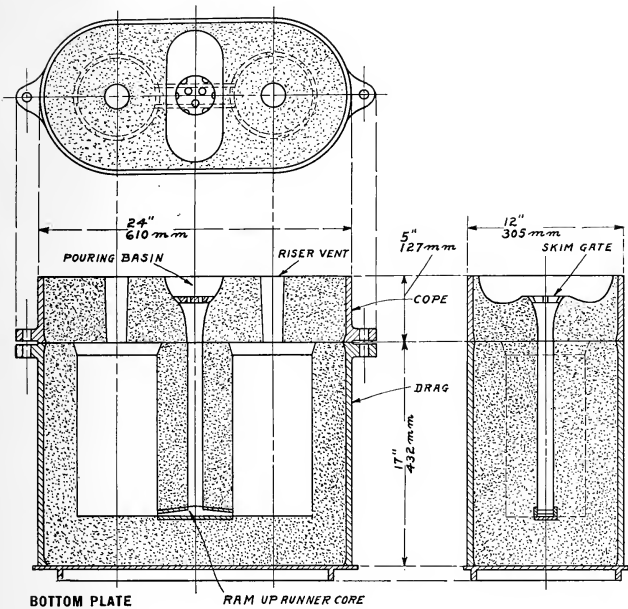

Fig. 9. Plan and Sections of a Well Designed Mould, explaining the terms used in the following Chapters.

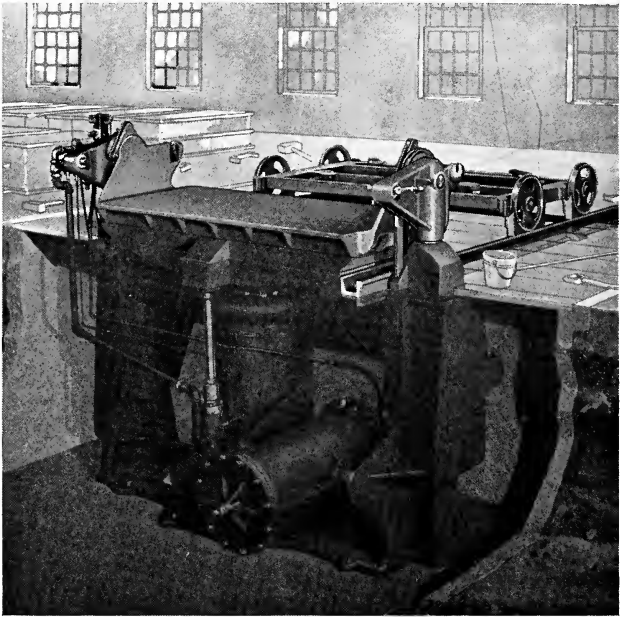

Fig. 10. A Large Roll-Over Jolt-Moulding Machine, with Foundations cut away to show the construction underneath the foundry floor.

CHAPTER II

Roll-Over Jolt-Moulding Machine for Large Moulds

In this chapter is shown a varied line of large castings that can be advantageously made on a Roll-Over Jolt-Moulding Machine, ranging in capacity from 3,000 pounds to 12,000 pounds, with a table length of 72 to 150 inches.

The machine shown on the opposite page has a table length of 106 inches and a lifting capacity of 7,000 pounds.

The operations performed are jolting, rolling over the flask, lowering the mould on a receiving table, and drawing the pattern. These operations are accomplished by the use of compressed air at a pressure of 80 pounds per square inch.

The pattern draw on a machine of this type should be positive and extremely accurate. In some instances manufacturers require a micrometer test from each machine before shipment; the variation being held to less than .0005" per inch of travel.

Lubrication is of the utmost importance, and the jolting valve and piston should be equipped with a forced-feed oiling system or some other means of supplying sufficient lubrication. Wherever possible, all working parts should be encased to prevent the entrance of sand, grit, etc.

It must be understood that the machine method of producing moulds does not eliminate any of the various operations that are ordinarily necessary for the producing of the same moulds by hand or floor moulding. The moulding machine, therefore, can only be considered a means of reducing the amount of time and labor formerly necessary to perform the same series of operations. For the purpose of illustration, the attention of the reader is directed to the views on page 12 and likewise to the production table on the opposite page. From the figures in the production table, it becomes evident that nearly 50% of the time occupied in making the drag, without the aid of a moulding machine, was used in the ramming operation.

The operations required for the producing of a drag or cope mould on the machine shown on page 12 and the means by which those operations are performed are as follows:

It is assumed that the pattern has been secured to the table of the machine and the flask placed in its proper position and clamped to the pattern-plate. Sand is riddled into the flask to a depth sufficient to cover the face side of the pattern; the flask is then filled with sand directly from the sand supply; the sand conveying system shown in Figure 11 provides an easy and economical means of performing this operation (altho not a necessity and rarely used except in Specialty Foundries). After the flask is filled, the operator in charge of the machine opens a valve, admitting compressed air to the jolt cylinder thru the jolt valve; the jolt piston rises and falls, carrying with it the table on which the pattern and flask are mounted; the mould is jolted or jarred at the rate of 100 to 160 blows per minute. (20 to 80 blows are used per mould, the number of blows necessary being dependent on the depth of the flask and density desired.) After being jolted, the flask is "butted off" and then "struck off" and the bottom plate securely fastened to the flask; iron "C" clamps (which are tightened by means of wedges driven between the clamp and the bottom plate) have been found to be excellent for this purpose. The ramming is now complete and the mould ready for rolling over.

The operator then opens an air valve, admitting compressed air to the roll-over cylinder, which raises the table on which the pattern is mounted and, in its upward travel, rolls over the mould. The table is securely locked in this position and a car known as a "run-out car," provided with devices that level the mould, is run into the space underneath the mould; the mould is then lowered upon the car by allowing the air in the cylinder to escape; when lowered, the leveling devices are adjusted to any unevenness of the bottom plate, after which the clamps, securing the flask to the pattern, are removed.

The vibrators, which are devices similar to pneumatic hammers, and are secured to the table upon which the pattern is mounted, are set in operation and impart a vibratory action to

the pattern serving to loosen the pattern in the sand. This action does not perceptibly enlarge the impression of the pattern in the mould. With the vibrators in operation, the valve admitting the air to the roll-over or draw cylinder is again opened and the pattern drawn from the mould, the speed with which the pattern is drawn being perfectly controlled by the operator. The mould, now resting on the car, is next run out from beneath the pattern; the roll-over table, on which the pattern is mounted, is unlocked and tilted slightly, after which the compressed air is released from the roll-over cylinder, and the roll-over table, with the pattern, returns to the jolting position, ready for another empty flask for making the next mould.

In order to more clearly set forth the advantages to be gained by the use of the Jolt-Moulding methods, a tabulation has been made showing the machine best adapted for producing the cope and the drag, also the production that can be obtained by the use of the two different styles of Jolt-Moulding Machines. The tabulation shows clearly that the greatest production is accomplished by the machine that produces mechanically all the operations required to make the mould.

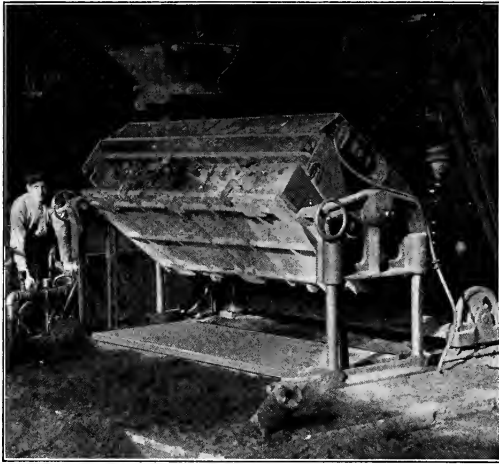

Fig. 11. Tunnel Segment Mould—Lower or Drag Half—Made on a Roll-Over Jolt Machine. In the view shown above, the machine is rolling over the mould after it has been jolted and bottom board clamped.

After the rolling-over operation is completed, the mould is lowered on the run-out car, shown in the rear, clamps removed and pattern drawn from the mould.



The lower view shows the completed lower half or drag mould before the core is set.

In the background can be seen the enormous production obtained, a performance which extended over a period of two years, resulting in a large saving over the hand-rammed method.

Fig. 12. Tunnel Segment Mould—Upper half or Cope—Made on a 42" x 97" plain jolt-moulding machine.

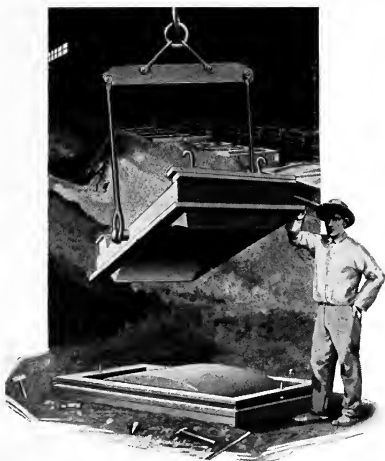
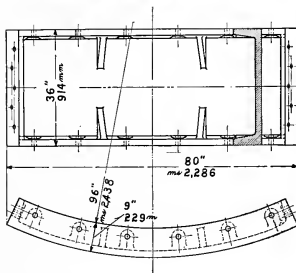

Fig. 13. Tunnel Segment Casting weighing 1500 pounds, used in making tunnel linings for the New York subway system.



PRODUCTION

Method of Moulding	No. Men	Hours	Quan. Moulds	% Increase
Without Machine	2	9	7
Cope—42" x 97" Plain Jolt.....	2	9	14	100%
Drag—42" x 97" Plain Jolt.....				
Cope—42" x 97" Plain Jolt.....	6	9	*141	670%
Drag—42" x 106" R. O. Jolt.....				

* With sand conveying system.

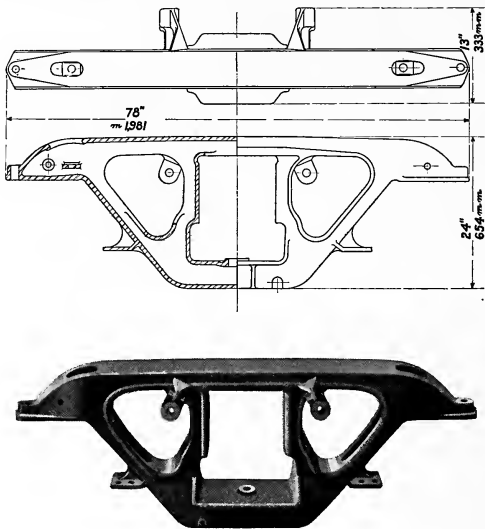

Fig. 14. Railway Truck Frame Steel Casting—Weight 470 pounds. The standardization of railway equipment has resulted in large quantity production of the various castings.

The production figures given below are based on using two machines of the Roll-Over Jolt type—one for the lower or drag half and the other for the upper or cope half of the mould.

PRODUCTION

Method of Moulding	No. Men	Hours	Quan. Moulds	% Increase
Without Machine	5	9	15
Cope—42" x 97" Plain Jolt.....	5	9	*40	166%
Drag—42" x 97" Plain Jolt.....				
Cope—42" x 106" R. O. Jolt.....	7	9	*120	470%
Drag—42" x 106" R. O. Jolt.....				

* With sand conveying system.

The shipbuilding industry has not attained the quantity production shown on the preceding pages, yet a very great saving can be made by the use of moulding machinery on smaller quantity production as is shown in the following tabulations.

The production figures given below are based on making the cope and drag moulds on the same machine.

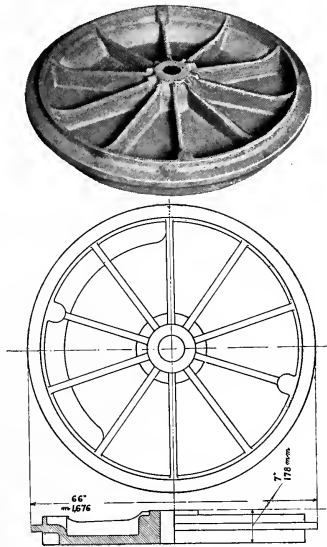

Fig. 15. Marine Engine Cylinder Head—Weight 2400 pounds.

PRODUCTION

Method of Moulding	No. Men	Hours	Quan. Moulds	% Increase
Without Machine	4	9	1
Cope—72"x72" Plain Jolt.....	4	9	2	100%
Drag—72"x72" Plain Jolt.....				
Cope—60"x92" R. O. Jolt.....	4	9	3	200%
Drag—60"x92" R. O. Jolt.....				

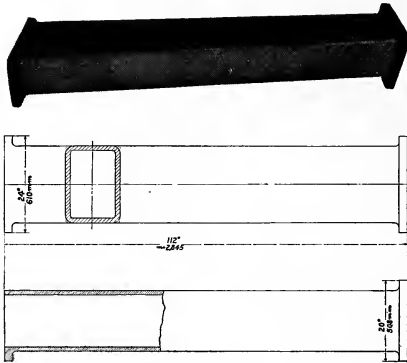

Fig. 16

Marine Engine Column—Weight 4000 pounds.

Where the quantity of castings required from one pattern is not sufficient for continuous production, or even for a full day's production, any number of different patterns can be used during the day. The changing of the pattern on the Roll-Over Jolt-Moulding Machine requires only a few minutes of time.

The production figures given below are based on making the cope and drag moulds on the same machine.

PRODUCTION

Method of Moulding	No. Men	Hours	Quan. Moulds	% Increase
Without Machine	4	9	1
Cope—42"x97" Plain Jolt.....				
Drag—42"x97" Plain Jolt.....	4	9	2	100%
Cope—66"x150" R. O. Jolt.....				
Drag—66"x150" R. O. Jolt.....	4	9	5	400%

A large number of machine tool castings are adaptable for machine moulding, particularly on the Roll-Over Jolt type of machine.

In some instances, where a casting does not readily lend itself to machine moulding, a slight change can be made in the design without impairing its utility or strength, thereby making it possible to mould on machines.

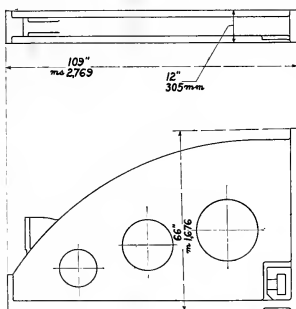

Fig. 17

Planer Housing Casting—Weight
5000 pounds.

The production figures given below are based on making the cope and drag moulds on the same machine.

PRODUCTION

Method of Moulding	No. Men	Hours	Quan. Moulds	% Increase
Without Machine	4	9	1
Cope—72"x72" Plain Jolt.....	4	9	2	100%
Drag—72"x72" Plain Jolt.....				
Cope—66"x150" R. O. Jolt.....	4	9	5	400%
Drag—66"x150" R. O. Jolt.....				

Milling Machine Column. Weight of Casting—700 pounds.

A 45"x72" Roll-Over Jolt-Moulding Machine made both the upper or cope half and lower or drag half of the mould for producing this casting.

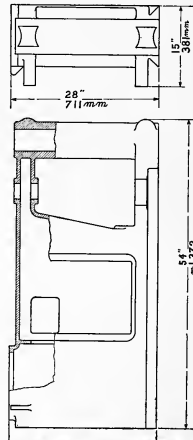

The production figures given below are based on making the cope and drag moulds on the same machine.



Fig. 18

PRODUCTION

Method of Moulding	No. Men	Hours	Quan. Moulds	% Increase
Without Machine	4	9	4
Cope—54"x66" Plain Jolt.....	4	9	8	100%
Drag—54"x66" Plain Jolt.....				
Cope—45"x72" R. O. Jolt.....	4	9	14	250%
Drag—45"x72" R. O. Jolt.....				

A Milling Machine Base Casting made on a Roll-Over Jolt-Moulding Machine having an over-all flask capacity of 45" in width by 72" in length. This machine is capable of jolting and rolling over half moulds up to 4,000 pounds in weight.

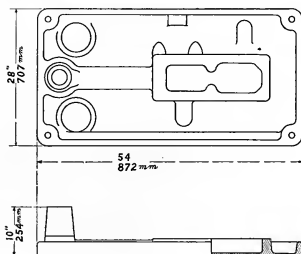

Fig. 19

Weight of Casting—1040 pounds.

The production figures given below are based on making the cope and drag moulds on the same machine.

PRODUCTION

Method of Moulding	No. Men	Hours	Quan. Moulds	% Increase
Without Machine	3	9	4
Cope—54" x 66" Plain Jolt.....	3	9	8	100%
Drag—54" x 66" Plain Jolt.....				
Cope—45" x 72" R. O. Jolt.....	3	9	18	350%
Drag—45" x 72" R. O. Jolt.....				

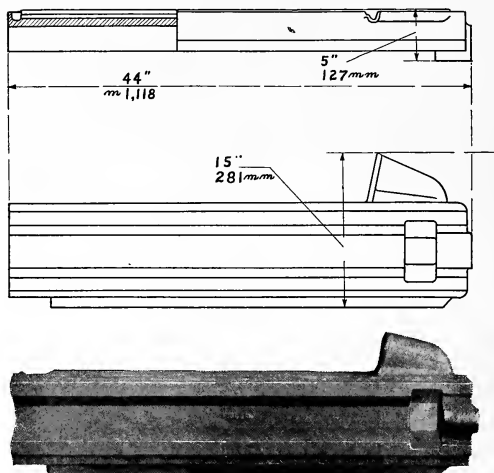

Fig. 20

Milling Machine Table Casting—Weight 500 pounds.

A 45"x72" Roll-Over Jolt-Moulding Machine made the moulds for producing this casting. Its simplicity in design makes possible a large production by hand moulding, yet a very large increase has been obtained by machine moulding, as noted in the following tabulation.

The production figures given below are based on making the cope and drag moulds on the same machine.

PRODUCTION

Method of Moulding	No. Men	Hours	Quan. Moulds	% Increase
Without Machine	3	9	11
Cope—42"x60" Plain Jolt.....	3	9	18	64%
Drag—42"x60" Plain Jolt.....				
Cope—45"x72" R. O. Jolt.....	3	9	32	190%
Drag—45"x72" R. O. Jolt.....				

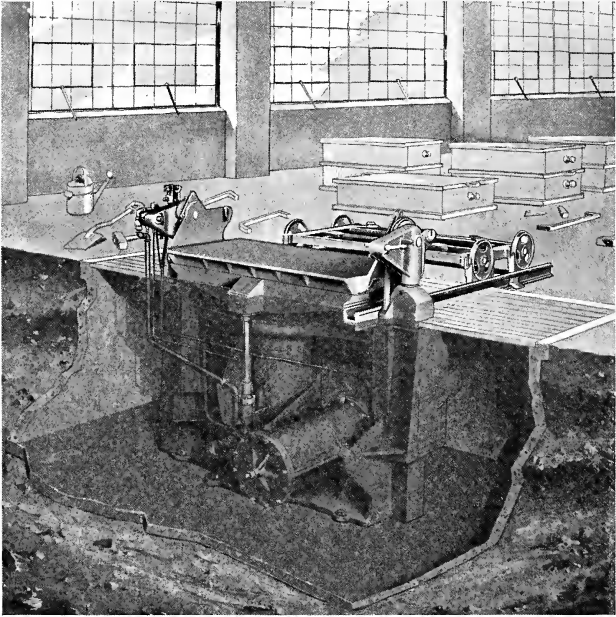

Fig. 21. A 34"x64" Roll-Over Jolt-Moulding Machine, having a lifting capacity of 2,000 pounds.

CHAPTER III

Roll-Over Jolt-Moulding Machine for Medium Size Moulds

The medium size Roll-Over Jolt-Moulding Machine, ranging in capacity from 1,000 to 2,000 pounds, is adapted for producing a large variety of castings, a number of which are illustrated on the following pages.

The operations performed are jolting, rolling over the flask, lowering the mould on a receiving table, and drawing the pattern. These operations are accomplished by the use of compressed air at a pressure of 80 pounds per square inch.

The pattern draw on a machine of this type should be positive and extremely accurate. In some instances manufacturers require a micrometer test from each machine before shipment, the variation being held to less than .0005" per inch of travel.

Lubrication is of the utmost importance; therefore, the jolting valve and piston should be equipped with a forced feed oiling system or other means of applying sufficient lubrication. Whenever possible, all working parts should be incased to prevent the entrance of sand, grit, etc.

In order to more clearly set forth the advantages to be gained by the use of the Jolt-Moulding methods, a tabulation has been made showing the machine best adapted for producing the cope and the drag, also the production that can be obtained by the use of the two different styles of Jolt-Moulding Machines.

The tabulation shows clearly that the greatest production is accomplished by the machine that performs mechanically all the operations required to make the mould.

On page 9 a description of this type of machine is given, together with complete details of the operation, and the reader should refer to this description for detailed information. It should, however, be here stated that the operation of this machine, when producing a mould, is as follows:

First, the empty flask is placed over the pattern on the roll-over table of the machine; it is now ready for the sand, which

should fill the flask completely with a heap of 3" or 4" above the top of the flask; the compressed air now admitted to the jolting cylinder rams the mould in from 20 to 40 blows, requiring 8 to 16 seconds of time. While the jolting of the mould is in process, it is well to push the heap of sand above the flask that is being jolted, to the edges and corners of the flask, in order that the sand may be well packed into these places before the jolting action is complete. The loose sand at the top is then "butted off," the bottom board and flask clamped to the roll-over table, after which it is rolled over by applying compressed air to the roll-over or draw cylinder. The rolling-over action having been completed, the mould is then lowered and comes to rest above the receiving car, which is run in place while the mould is being rolled over. The automatic leveling pins, coming in contact with the uneven surfaces of the bottom board, are now clamped by the use of one lever, after which the mould is ready to have the pattern withdrawn. This is accomplished by first releasing the clamps required in rolling over, and then the air applied to the roll-over or draw cylinder, which causes the pattern to be steadily and carefully withdrawn from the sand.

It is important, when providing the equipment for this particular type of machine, to give particular attention to what is known as the flask space, provided for on the roll-over table. The parts to be occupied by the flask space include: First, the pattern-plate; second, the flask; third, the total height of the bottom board; fourth, the amount of filling blocks, or the additional thickness of the pattern-plate that is required to fill the space unoccupied by the thickness of the first three parts mentioned.

The dimension of the flask space is constant for each machine and regardless of the combined thickness of the first three requirements, the fourth requirement must be met in order to produce a properly working machine.

After the mould has been jolted, rolled over and again lowered on the receiving car, it should come in contact with the automatic leveling pins, depressing them a slight distance, about $\frac{1}{4}$ " to $\frac{3}{8}$ " being the desired amount. While the mould is now

at rest and hanging freely in this position, the flask equipment occupying the flask space must not be so great as to exceed the proper dimension given, for if it does, the bottom board, which is clamped to the mould, will then come in contact with the frame of the leveling car, in which case proper alignment could not be obtained. In other words, after the mould has been rolled over and lowered to a position of rest above the receiving car, there should be no part of the bottom board in contact with the receiving car except that portion coming in contact with the depressible leveling pins which, however, should not be depressed to the full depth of their stroke.

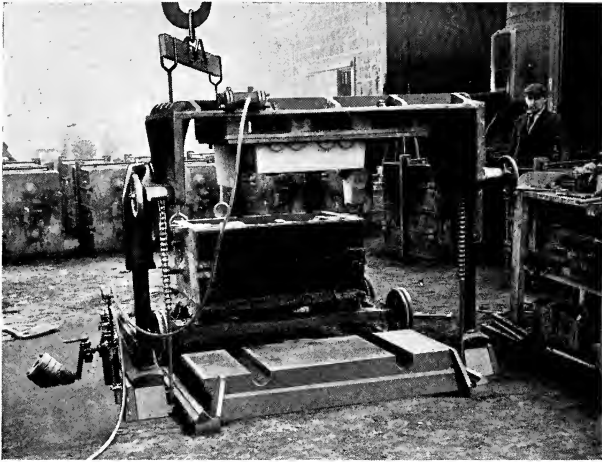

Fig. 22

Automobile Cylinder with Upper Half of Crank Case cast en bloc—Made on a Roll-Over Jolt-Moulding Machine.

This view shows the pattern drawn from the mould, which is deposited on the run-out car and ready for the crane to remove to the foundry floor for setting the core.

After sufficient drags have been made to begin core-setting, the drag pattern is removed from the machine and the cope pattern substituted. This changing of pattern consumes about five minutes in time, as only four bolts are used in securing it to the roll-over table.

Foundries producing these castings in large quantities find it advisable to use two machines in producing the mould—one to be used in making the cope half and the other the drag half of the mould.

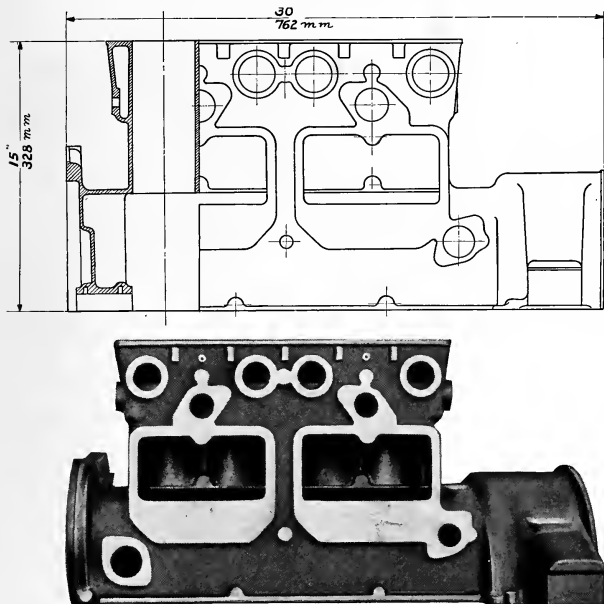

Fig. 23

Automobile Cylinder en bloc. Weight 175 pounds.

The production figures given below are based on making the cope and the drag on the same machine.

PRODUCTION

Method of Moulding	No. Men	Hours	Quan. Moulds	% Increase
Without Machine	2	9	2
Cope—36"x48" Plain Jolt.....	2	9	4	100%
Drag—36"x48" Plain Jolt.....				
Cope—34"x64" R. O. Jolt.....	4	9	48	1150%
Drag—34"x64" R. O. Jolt.....				

An Automobile Truck Wheel produced in a steel foundry.

Beginning work in the morning, 10 to 15 drags are made, permitting the core-setter to start work. The drag pattern is then removed from the machine and the cope half of the mould is made. Rotation in this manner makes possible the closing of the mould before the floor is completely filled.

If the quantity is sufficient, it is advisable to use two machines, one for the cope and one for the drag.

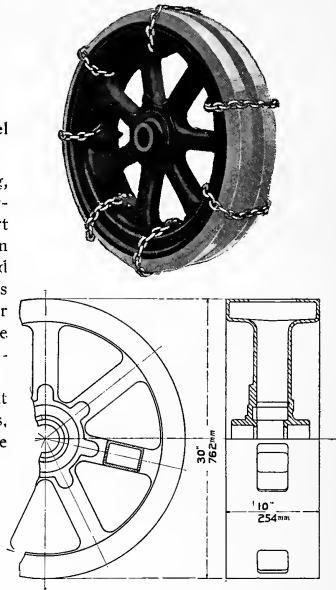

Fig. 24
Weight 240 pounds.

The production figures given below are based on making the cope and drag moulds on the same machine.

PRODUCTION

Method of Moulding	No. Men	Hours	Quan. Moulds	% Increase
Without Machine	3	9	9	...
Cope—42"x50" Plain Jolt.....	3	9	18	100%
Drag—42"x60" Plain Jolt.....				
Cope—34"x64" R. O. Jolt.....	3	9	45	400%
Drag—34"x64" R. O. Jolt.....				

Remarkable progress is being made on tractor work and the large quantity of castings required makes machine moulding a necessity.

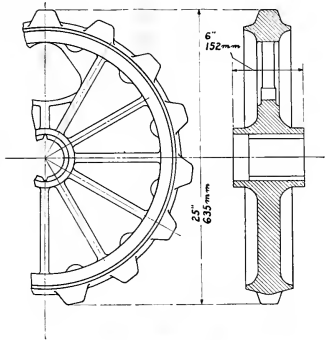

A pair of 34"x64" Roll-Over Jolt-Moulding Machines were used in obtaining the production noted below, one making the cope half and the other the drag half of the mould.



Fig. 25
Tractor Sprocket Wheel—
Weight 115 pounds.

PRODUCTION

Method of Moulding	No. Men	Hours	Quan. Moulds	% Increase
Without Machine.....	6	9	30
Cope—36"x48" Plain Jolt	6	9	60	100%
Drag—36"x48" Plain Jolt				
Cope—34"x64" R. O. Jolt	6	9	125	317%
Drag—34"x64" R. O. Jolt				

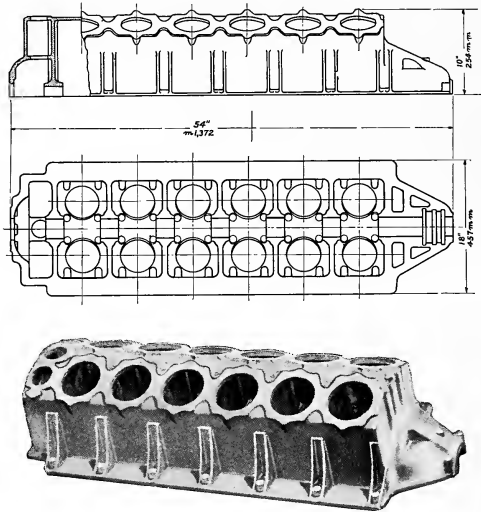

Fig. 26

The Upper Half of Liberty Motor Aluminum Crank Case—made on a 34"x70" Roll-Over Jolt-Moulding Machine.

The large production noted in the tabulation below was obtained with a pair of these machines, one making the upper or cope half and the other the lower or drag half of the mould.

Weight of casting 100 pounds.

PRODUCTION

Method of Moulding	No. Men	Hours	Quan. Moulds	% Increase
Without Machine	8	9	16
Cope—42"x60" Plain Jolt.....	8	9	32	100%
Drag—42"x60" Plain Jolt.....	8	9	32	100%
Cope—34"x70" R. O. Jolt.....	8	9	102	540%
Drag—34"x70" R. O. Jolt.....	8	9	102	540%

Steel Casting of a lower Ball Race for 6 ton Armored Truck. Made on a 32" x 54" Roll-Over Jolt-Moulding Machine. A dense and uniform casting is very essential in work of this kind. Loss from defective castings is reduced to a minimum by machine moulding, thus making a saving in labor and metal and also increasing the production.

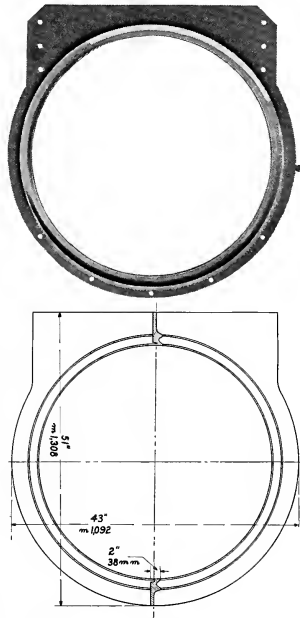

Fig. 27

Weight 230 pounds.

Production based on using one machine for both the cope and the drag half of the mould.

PRODUCTION

Method of Moulding	No. Men	Hours	Quan. Moulds	% Increase
Without Machine	3	9	20
Cope—24"x36" Plain Jolt.....	3	9	32	60%
Drag—24"x36" Plain Jolt.....				
Cope—32"x54" R. O. Jolt.....	3	9	45	125%
Drag—32"x54" R. O. Jolt.....				

Milling Machine Drive Pulley.



Weight of casting 200 pounds.

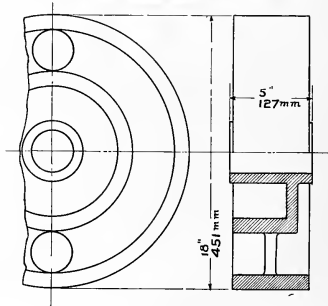

Fig. 28

Production based on using one machine for both the cope and the drag half of the mould.

PRODUCTION

Method of Moulding	No. Men	Hours	Quan. Moulds	% Increase
Without Machine	3	9	20
Cope—24" x 36" Plain Jolt.....	3	9	32	60%
Drag—24" x 36" Plain Jolt.....				
Cope—32" x 54" R. O. Jolt.....	3	9	45	125%
Drag—32" x 54" R. O. Jolt.....				

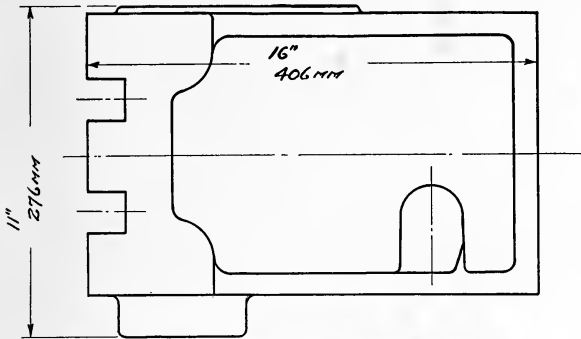

Fig. 29

Milling Machine Headstock. Weight of casting 250 pounds.

Production based on using one machine for both the cope and the drag half of the mould.

PRODUCTION

Method of Moulding	No. Men	Hours	Quan. Moulds	% Increase
Without Machine	3	9	18
Cope—24"x36" Plain Jolt.....	3	9	24	33⅓%
Drag—24"x36" Plain Jolt.....				
Cope—32"x54" R. O. Jolt.....	3	9	38	111%
Drag—32"x54" R. O. Jolt.....				

Casting used in the Shipbuilding Industry.

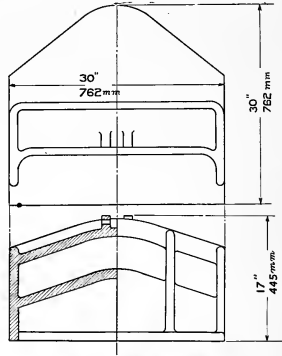

Towing Chock. Weight 500 pounds.

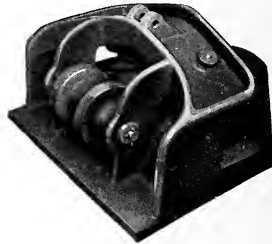
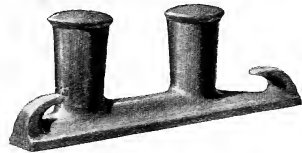

Fig. 30

Production based on using one machine for both the cope and the drag half of the mould.

PRODUCTION

Method of Moulding	No. Men	Hours	Quan. Moulds	% Increase
Without Machine	4	9	4
Cope—36"x48" Plain Jolt.....	4	9	8	100%
Drag—36"x48" Plain Jolt.....				
Cope—34"x64" R. O. Jolt.....	4	9	20	400%
Drag—34"x64" R. O. Jolt.....				



Casting used in the Ship-building Industry

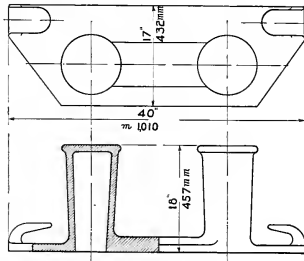

Fig. 31

Combination Mooring Timberhead.

Production based on using one machine for both the cope and the drag half of the mould.

PRODUCTION

Method of Moulding	No. Men	Hours	Quan. Moulds	% Increase
Without Machine	4	9	5
Cope—42"x60" Plain Jolt.....	4	9	9	80%
Drag—42"x60" Plain Jolt.....				
Cope—34"x64" R. O. Jolt.....	4	9	22	340%
Drag—34"x64" R. O. Jolt.....				

Shipbuilding Industry

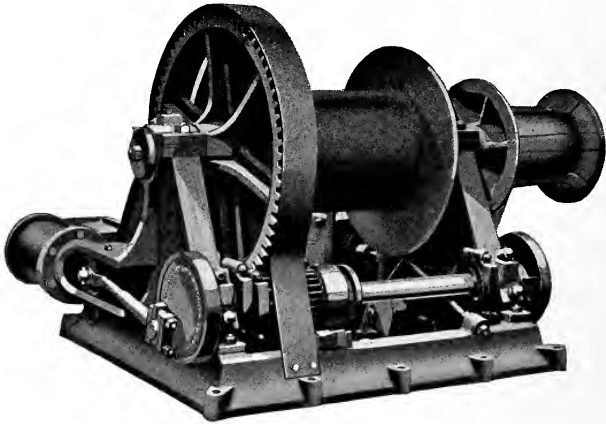

Fig. 32. 8"x10" Single Drum Hoisting Engine.

A double cylinder engine used principally for mooring on the after end of the large ore boats.

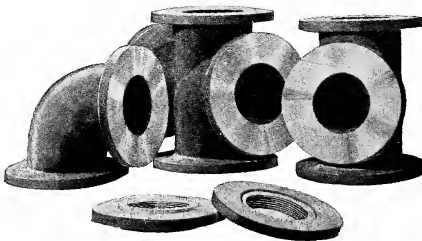

Fig. 33. Flanged Pipe Fittings.

Made principally of semi-steel or cast iron

Shipbuilding Industry

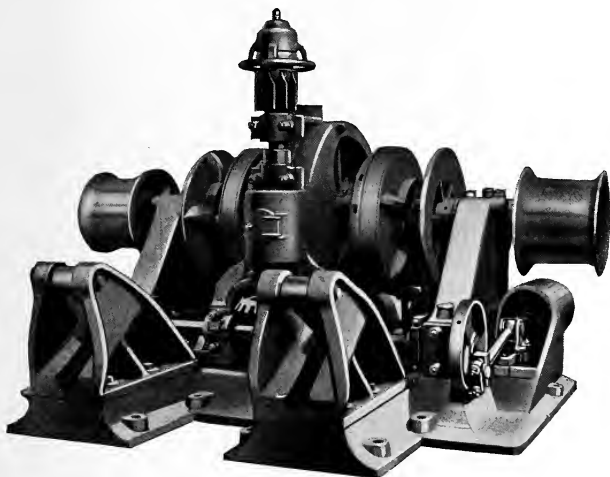

Fig. 34. 10"x10" Globe Windlass Engine.

The photographs on this and the opposite page show the construction of a marine deck engine and windlass in detail.

Practically all castings, such as the winch head, winding drum, brackets, cylinder, plate, bed, pipe fittings, etc., are adaptable for moulding on the Roll-Over Jolt type of machine.

Shipbuilding Industry

CASTINGS REQ'D		MACHINE MouldING				HAND MouldING			SAVING		
Name	Quant	R.O. Mach.	Out-Put	No. Men	Cost Each	Out-Put	No. Man	Cost Each	Value	%	Man Days
12" Bits - C	600	45"x72" 2 bx	30	4	\$.70	2	2	\$5.25	\$2730.	86	520
Core	2400	32"x64"	140	2	.086	16	1	.375	695.	77	116
TOTAL				6			3		3423.		636
9" Bits - B	1800	45"x72" 2 bx	36	4	.60	3	2	3.50	5220.	83	992
Core	7000	32"x64"	140	2	.086	36	2	.33	1780.	74	296
TOTAL				6			4		7000.		1288
6" Bit - A	600	34"x64"	40	3	.413	6	2	1.75	802.	76	155
Core	1200	22"x37"	160	1	.04	26	1	.24	240.	83	40
TOTAL				4			3		1042.		195
Mooring Rings Dwg. H-52 #d	1200	34"x64"	40	4	.525	9	6	3.50	4462.	85	850
Core #d	2400	22"x37"	100	2	.12	18	1	.33	630.	63	107
TOTAL									5092.		957

Fig. 35

Tabulation showing production by machine and by hand moulding on a number of ship castings. The total value of saving by machine moulding on the quantity noted amounts to \$16,557.00.

The total amount of labor by hand moulding.....3,767 man days

The total amount of labor by machine moulding..... 691 " "

Saving in labor3,076 " "

Average percentage of saving.....81%

Shipbuilding Industry

CASTINGS REQ'D Name	MACHINE MOULDING				HAND MOULDING			SAVING		
	Mach	Out Put	No Men	Cost Each	Out Put	No Men	Cost Each	Value	%	Men Days Per Mo.
Driving Collar (28" dia.)	32"x64"	40	2	.26	3	1	3.50	3.24	93	294
Windlass Side	32"x64"	24	2	.44	3	1	3.50	3.06	87	156
Several Small Elbows; Ash Gun Baffle Plates; Discharge Valve - Chest Liner	32"x64" or 22"x37"	40-50 of any of these	2	.21 to .26	4 to 6	2	1.76 to 2.62	1.54 to 2.36	88 to 90	520

Fig. 36

Total saving per month.....\$8,076.64
 Total saving in labor.....1,534 man days
 Average percentage of saving.....84%

CASTINGS REQ'D Name	MACHINE MOULDING				HAND MOULDING			SAVING		
	R.O. Msch	Out Put	No Men	Cost Each	Out Put	No Men	Cost Each	Value	%	Men Days Per Mo.
Housing Slides	34"x64"	40	3	.41	4	1	1.50	1.09	73	182
Winch Head (Catg. 24" dia. Bot. 18" " top)	34"x64"	40	3	.41	2	2	5.25	4.84	92	962
Anchor Chain Stopper	34"x64"	12	3	1.38	1 in 1-2/3 days	2	7.00	5.62	80	338

Fig. 37

Total saving per month.....\$8,347.00
 Total saving in labor.....970 man days
 Average percentage of saving.....89%



Fig. 38. A Floor of Automobile Casting Moulds in the Plant of the Allene-Ryan Foundry Co., Cleveland, Ohio, U.S.A.

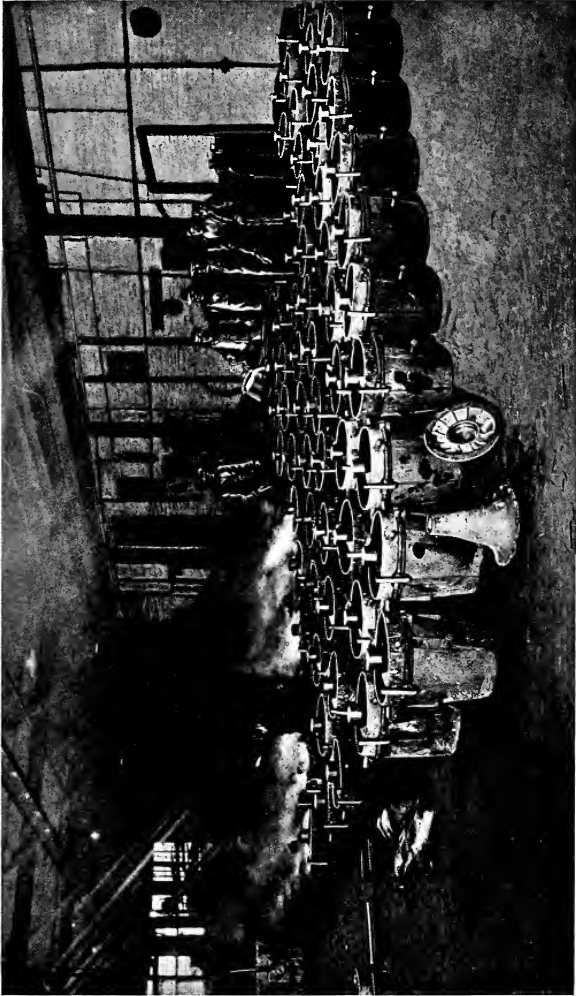

Fig. 39. Fordson Tractor Housing—Made by The Ferro Machine and Foundry Co., Cleveland, Ohio, U.S.A.



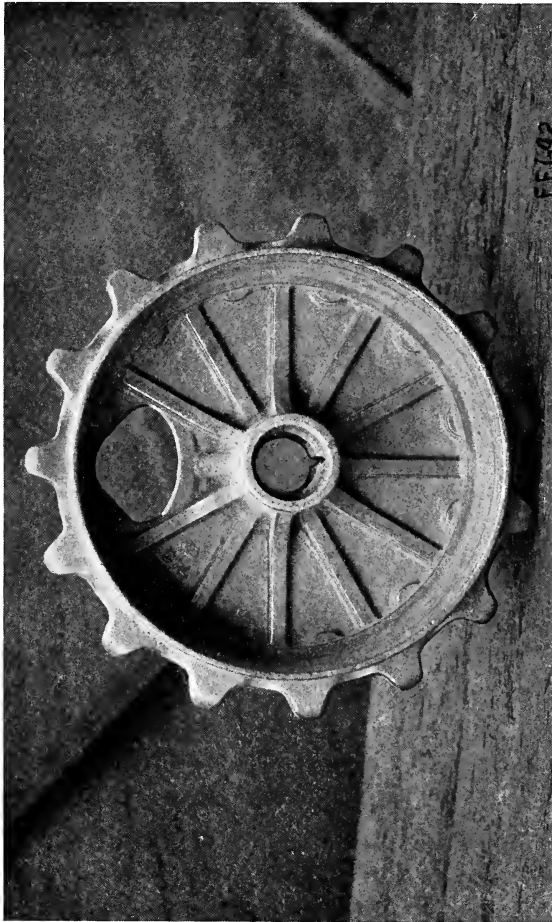

Fig. 40. Upper View—The day's production in Semi-steel.

Fig. 41. Lower View—The Farm Tractor Sprocket that was made.





Fig. 42. Upper View—At the Plant of The Interstate Foundry Co., Cleveland, Ohio.
Fig. 43. Lower View—Six Cylinder en bloc Automobile Casting made from above moulds.



Fig. 44. Castings Produced by machine moulding at The Modern Foundry Co., Cincinnati, Ohio, U.S.A.

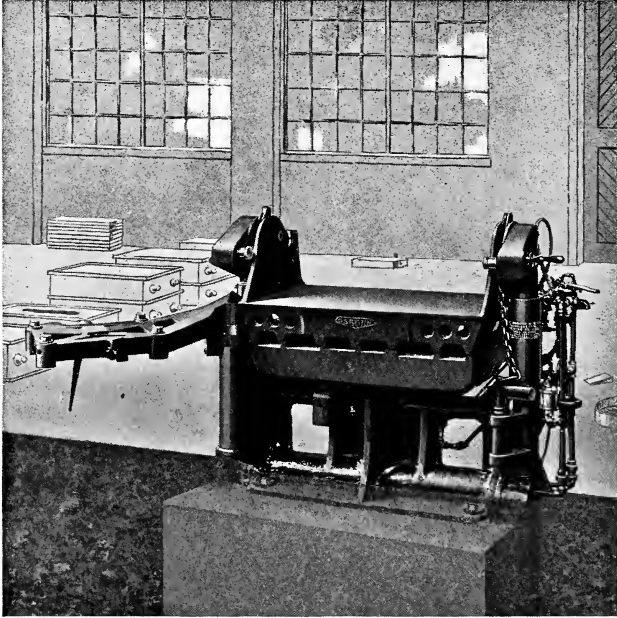

Fig. 45. A 22"x37" Roll-Over Jolt-Moulding Machine, having a lifting capacity of 800 pounds, showing foundation setting.

CHAPTER IV

Roll-Over Jolt-Moulding Machine for Small Moulds

The good results produced from the use of Jolt-Moulding machines on the large and medium sized work, creates a demand for a Jolt-Moulding Machine that will quickly handle the many small patterns adaptable to jolt-moulding. The machine should be small, self-contained and protected from sand and grit.

It should not require a pit in which to set, nor should the falling sand from the flask obstruct its working.

The different operations of the machine should be performed in the simplest manner possible and without consuming an excessive amount of time. Especially is this true of the operations other than the jolting of the mould, as when these operations are compared with the operations of a moulder making a mould on the floor, it is evident that he does not spend much time in clamping the bottom board onto the flask, or the rolling over of the mould, and, therefore, these operations when performed on the machine and viewed from the standpoint of time, alone, require the utmost speed in the operation of the machine. However, there enters at this point an element not thus far considered, i. e., while the moulder can perform a few of the individual operations when making the mould on the floor, in the same time or even faster than the time of the machine, nevertheless, it is the performing of these operations throughout the entire day that consumes the vitality and strength of the moulder, and it is a fact that in the latter part of the day his operations are not nearly as speedy as they were at the beginning of the day's work, while on the other hand, the operations performed by machine power are constant throughout the entire day and with very little effort on the part of the operator.

There was a time, now past, when these most vital points did not require the consideration that must now be given them, for at that time there was an abundance of manpower available;

workmen could be had to perform these tasks at a low rate of wages, and the workman, in order to secure a livelihood and perform the tasks required of him if he was to retain his position, produced, at the expense of breaking down his health and strength, a large day's work. Conditions, however, have changed and those days have seemingly passed forever, as the workman has come to a position where he is satisfied that he should produce the necessities of a livelihood without the hard work which in the past has been so necessary to maintain a satisfactory foundry production. He is beginning to realize that the manufacturer and foundryman should furnish him with machines that will perform the heavy and drudging part of the day's work, without exacting the maximum of his effort, and yet produce equal or greater results than those obtained by the old time methods.

For producing the smaller size of what we have termed "Small Moulds," there has been a demand for a Roll-Over Jolt-Moulding Machine mounted on wheels, either operating on the foundry floor or on Tee rails, placed in the foundry floor in such a manner that the machine can be conveyed from one end of the floor to the other. The claim is made that the distance the moulds are carried from the machine to the floor being less than when the machine is permanently located in position on the foundry floor, a greater production can be obtained with less effort on the part of the operators. Others maintain that the machine permanently located has an advantage over the portable machine, claiming that the time and energy consumed in moving the machine is equal to that required in carrying the moulds the short distance further. This again is largely a matter of individual preference and should be determined by the conditions in the foundry in which the machine is to be used. Many foundries, using this particular type of machine for small work, prefer to set it in a permanent location under the chute of a sand-conveying system, which has been found a highly desirable installation in foundries producing castings in large quantities, while others prefer to make use of the available sand-cutting machines in bringing the sand, after it has been tempered, from the floor into a pile alongside the mould-

ing machine, where it is then readily shoveled into the flask before the mould is made.

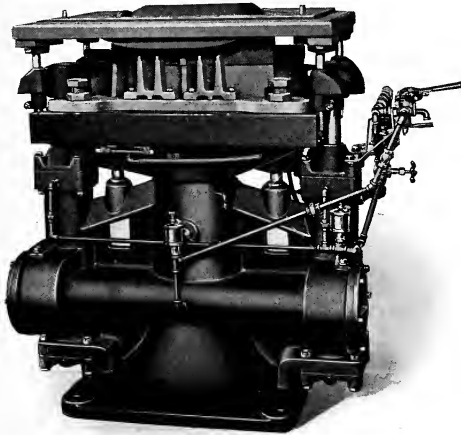

Fig. 46

A Stripping-Plate Jolt-Moulding Machine with Stripping Plate and Patterns Mounted.

While the Roll-Over Jolt-Moulding Machine is best adapted for general all-around small foundry work, nevertheless there are some patterns from which a large quantity of castings are to be made which can be best and most quickly made by machines without the roll-over operation. This machine is known as the Stripping-Plate Jolt-Moulding Machine, and as the name suggests, is used in connection with a stripping-plate. Such a machine, however, requires the highest grade of pattern equipment and cannot be used economically, considering the cost of equipment necessary, unless the quantity to be produced from the pattern runs well into the thousands. Such a machine is illustrated above, equipped with a stripping plate and set of patterns. Many of the large automobile manufacturers, producing automobiles running into the thousands per day, have

profitably used a highly specialized combination machine, which embodies a jolting operation, a squeezing operation, and the operation of rapidly drawing the mould from the pattern by means of a stripping plate.

The Roll-Over Jolt-Moulding Machine shown at the beginning of this chapter is operated by compressed air at 80 pounds per square inch; its functions are jolt-ramming, rolling over the mould, lowering the mould on the swing-out table and then drawing the pattern from the sand. After these operations are performed, the mould is swung clear of the machine, as is shown in the cuts on the following pages.

The numerous castings and foundry floors shown in this chapter will give a good idea of the production obtained and will suggest to the reader the great possibilities of machine moulding when applied to this class of work.

The castings produced by this type of machine are true to pattern, uniform in weight and, when they are machined by holding in jigs, have a decided advantage over the ones made by hand ramming.

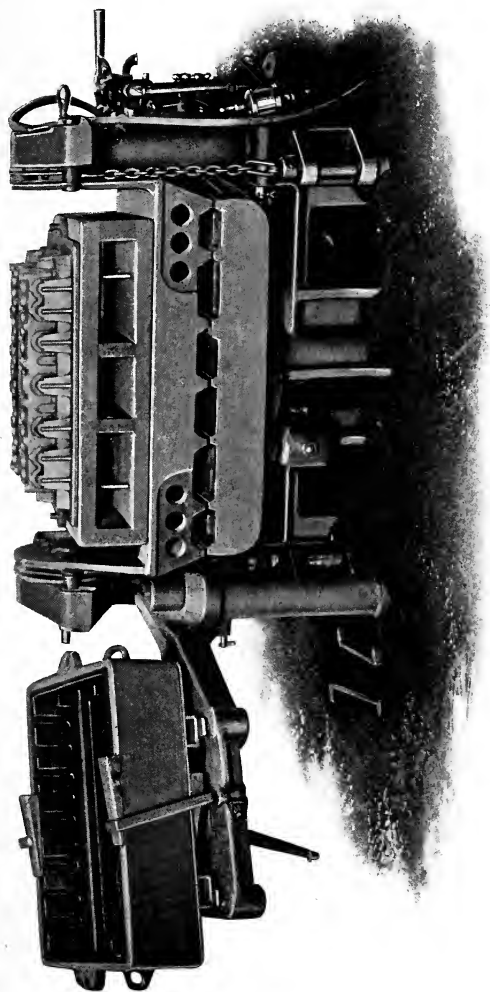
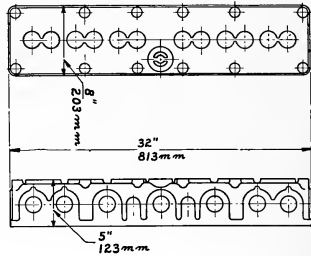

Fig. 47. An Automobile Cylinder Head—Two in a mould—made on a 22" x 37" Roll-Over Jolt-Moulding Machine
This view shows the mould deposited on the swing-out table and ready for removal to the foundry floor.
The roll-over table, to which the pattern is attached, is in its initial or jolting position.

Automobile Cylinder Head.



Weight 38 pounds



Fig. 48

Production based on making both the cope and the drag half of the mould on the same machine.

PRODUCTION

Method of Moulding	No. Men	Hours	Quant. Moulds	% Increase
Without Machine	3	9	30
Cope—20" x 27" Plain Jolt.....	3	9	60	100%
Drag—20" x 27" Plain Jolt.....				
Cope—22" x 37" R. O. Jolt.....	3	9	200	567%
Drag—22" x 37" R. O. Jolt.....				

Steel Casting Bracket for 6-Ton Armored Truck.



Weight 50 pounds.

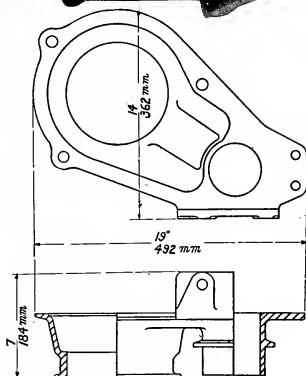

Fig. 49

Production based on making both the cope and the drag half of mould on the same machine.

PRODUCTION

Method of Moulding	No. Men	Hours	Quant. Moulds	% Increase
Without Machine	3	9	11
Cope—20" x 27" Plain Jolt.....	3	9	22	100%
Drag—20" x 27" Plain Jolt.....				
Cope—22" x 37" R. O. Jolt.....	3	9	36	227%
Drag—22" x 37" R. O. Jolt.....				

Steel Casting Sprocket for
6-Ton Armored Truck.



Weight 125 pounds.

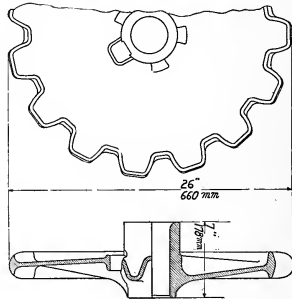

Fig. 50

Production based on making both the cope and the drag half of mould on the same machine.

PRODUCTION

Method of Moulding	No. Men	Hours	Quant. Moulds	% Increase
Without Machine	3	9	10
Cope—20" x 27" Plain Jolt.....	3	9	18	80%
Drag—20" x 27" Plain Jolt.....				
Cope—22" x 37" R. O. Jolt.....	3	9	32	220%
Drag—22" x 37" R. O. Jolt.....				



Fig. 51
High Pressure Steam Trap.

Weight 61 pounds.

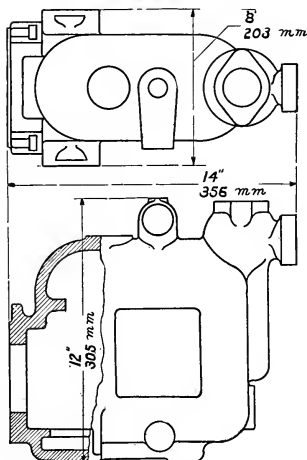

Production based on making both the cope and the drag half of mould on the same machine.

PRODUCTION

Method of Moulding	No. Men	Hours	Quant. Moulds	% Increase
Without Machine	2	9	18
Cope—20" x 27" Plain Jolt.....	2	9	27	50%
Drag—20" x 27" Plain Jolt.....				
Cope—22" x 37" R. O. Jolt.....	2	9	42	133%
Drag—22" x 37" R. O. Jolt.....				

Timberhead Casting.
Used in the Shipbuilding
Industry.

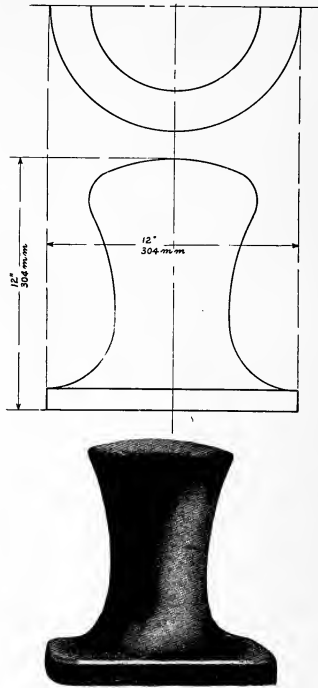

Fig. 52

Production based on making both the cope and the drag half of mould on the same machine.

PRODUCTION

Method of Moulding	No. Men	Hours	Quant. Moulds	% Increase
Without Machine	3	9	21
Cope—18" x 18" Plain Jolt.....	3	9	36	71%
Drag—18" x 18" Plain Jolt.....				
Cope—22" x 37" R. O. Jolt.....	3	9	48	130%
Drag—22" x 37" R. O. Jolt.....				



Cleat Casting.
Used in the Shipbuilding
Industry.

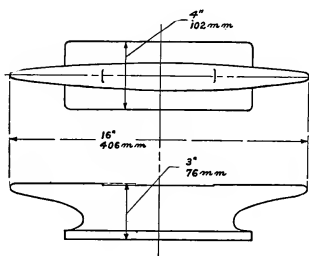

Fig. 53

Production based on making both the cope and the drag half of mould on the same machine.

PRODUCTION

Method of Moulding	No. Men	Hours	Quant. Moulds	% Increase
Without Machine	3	9	36
Cope—18" x 18" Plain Jolt.....	3	9	60	67%
Drag—18" x 18" Plain Jolt.....	3	9	60	67%
Cope—22" x 37" R. O. Jolt.....	3	9	100	180%
Drag—22" x 37" R. O. Jolt.....	3	9	100	180%

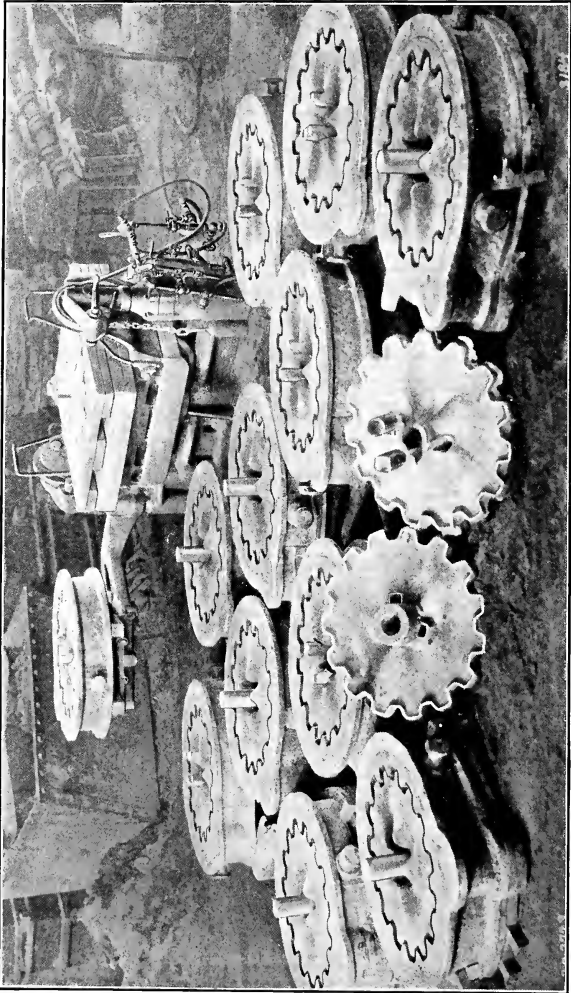

Fig. 54. Part of a day's output at the steel plant of The Wellman-Seaver-Morgan Co., Cleveland, Ohio, U. S. A.

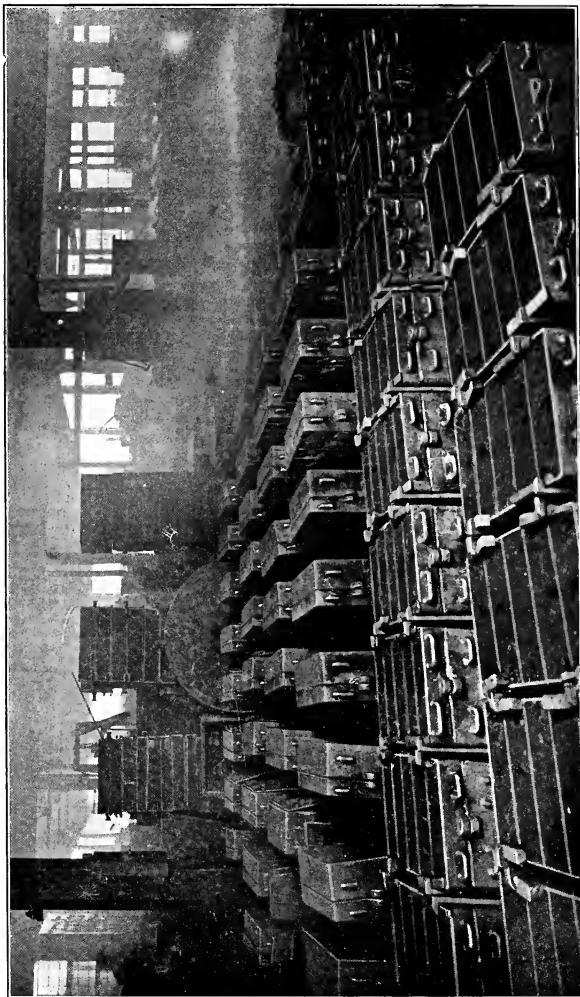

Fig. 55. A day's production of Cylinder Head Moulds from one machine.

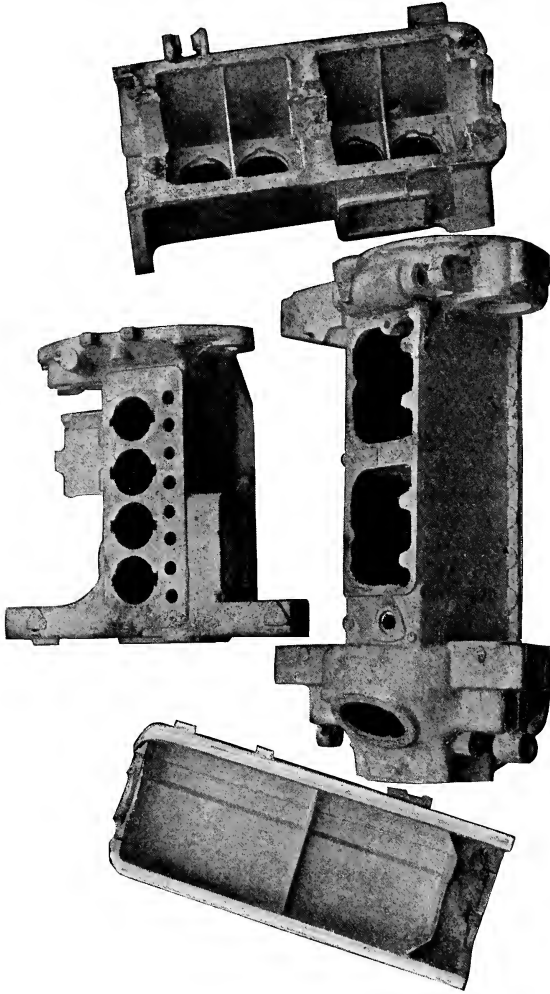

Fig. 56. A Group of Automobile Crank Cases made in the Plant of The City Brass Foundry Co., Cleveland, Ohio, U. S. A.

CHAPTER V

The Jolt-Moulding Machine in Aluminum and Brass Foundries

The Jolt-Moulding Machine, having had its early development in the iron and steel foundry, was somewhat slow in being accepted as a machine which would produce the proper kind of moulds for brass and aluminum castings. The pouring conditions in the aluminum and brass foundry are different from those in an iron or steel foundry, inasmuch as the pouring in the aluminum and brass foundries is taking place throughout the entire working day.

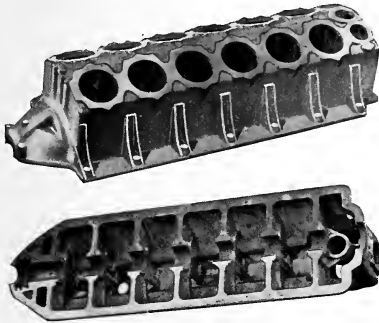

Fig. 57. Liberty Motor Crank Case—
Upper and Lower Half.

This method of operation made possible the production of castings in multiple numbers with an ex-

ceptionally small number of flasks and with a minimum of floor space; and then again, some difficulty was experienced in securing a jolt-moulding machine which would produce a blow suitable for the ramming of a mould of uniform density, and still leave the parts of the mould soft enough for the pouring of the aluminum. It was found, however, that the Roll-Over Jolt-Moulding Machine, by proper adjustment of its stroke and with proper pattern and flask equipment, could be made to produce the desired blow, which has resulted in many of the large brass and aluminum foundries of the United States being equipped with this type of machine. Perhaps it required the stress of war conditions, with the necessity for a large production with a minimum consumption of man-power, to force the development into a perfection of operation such as has rarely been experienced in the foundry industry.

The views in this chapter were made in the plant of the Aluminum Castings Company, Cleveland, Ohio, and show the complete process of moulding and easting the Liberty Motor Crank Cases.

When the American engineers designed and began building the Liberty Motors in quantity for Government aeroplanes, it was with the full realization of the possible difficulties that would be encountered before all of the many details were perfected and the engine pronounced a success, both



Fig. 58. Pattern Mounted on Roll-Over Jolt Machine.

from the viewpoint of reliability of operation and the practicality of its adaptation to manufacturing methods. The 400 H.P., which the motor was to develop, required materials, in fact demanded materials, that would be absolutely perfect in their metallurgical qualities and of the highest grade of workmanship.

Of the many different parts of the engine, the crank case is one that received a considerable amount of attention, as failure in this particular part practically meant complete destruction of the engine. The inspection, therefore, was carefully made and the materials held strictly to the specifications.



Fig. 59. Jolting the Drag Half of the Mould.

The aluminum foundries with the true Yankee spirit, began with a determined effort to produce castings that would pass inspection and fulfill all requirements of the specifications.

After the casting had been successfully produced, free from blowholes, cold shots, shrinkage strains, and internal stresses, the next question that confronted the foundry was one of production to meet the enormous re-

quirements demanded by the Government's program. The same determination that produced the casting successfully from the metallurgical standpoint, also solved the problem of producing the quantities required per day. The Roll-Over Jolt-Moulding Machine was, after due consideration, decided upon as being the one best adapted to produce the moulds.

An inside and an outside view of the casting are shown in Fig. 57. These views show clearly the construction of the casting, both of the top and bottom half.

The pattern mounted on the pattern plate and attached to the table of the moulding machine is shown clearly in Fig. 58. It will also be noted in this view that a finished drag mould is on the run-out car of the machine. The bottom boards that were used are seen standing against the foundry wall.

In Fig. 59 the flask is being filled with sand from



Fig. 60. Butting Off the Cope Half of Mould.

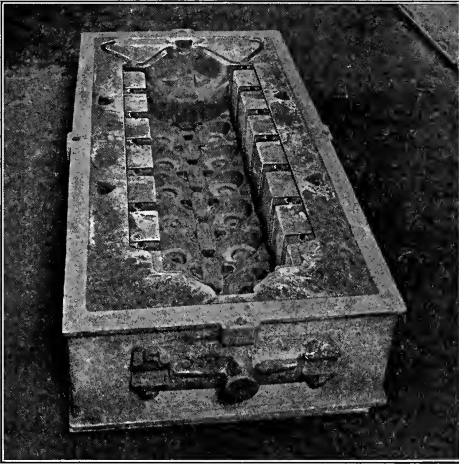

Fig. 61. Drag Half of Mould Ready for Setting the Cores.



Fig. 62. Drag Half of Mould with Cores Set.



Fig. 63. Making Cores on Small Jolt Machine.

flask equipment when attempting a large production. By analyzing the flask shown in Fig. 61 it will be seen that the flask provided is one well adapted to their work. The flask is made of aluminum, and the trunnion piece has been cast separately and provided with dovetailed slots at each end; the purpose of these slots is to receive the loose pieces that are used as handles in case it is desired to carry the flask without a crane. Bolts are used for securing this trunnion piece to the flask. This Figure also shows a splendid detail of the drag half of the mould, after the pattern has been withdrawn and the mould set on the foundry floor.

By referring to Fig. 62, this same drag half of the mould is shown with cores set and ready to receive the cope.

There are six separate cores used in the body of the

the chutes overhead, which are a part of the sand conveying system with which this plant is equipped.

In Fig. 60 the jolting operation of the cope half of the flask is completed and the workmen are "butting off" the loose sand on top of the mould, an operation which can be performed in eight or ten seconds of time.

Too much emphasis cannot be placed upon the necessity of providing the proper



Fig. 64. Completing Moulds Ready for Pouring.

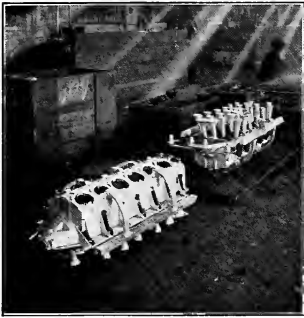

Fig. 65. Shaking Out the Moulds.

mould all practically the same in construction, and were made on a small Plain Jolt-Moulding Machine, as shown in Fig. 63. These cores were produced by first placing in the bottom of the core-box, a dry-sand slab in which had been placed suitable holding lugs to which the carrier handles are attached. The core-box is then filled with green sand and jolt-rammed.

The shape of the core demanded the hinge type of box which permitted the swinging of the box from off the core, after which it was carried to the green-sand core-racks.

In Fig. 64 may be seen a row of moulds, part of which are completed and ready for pouring, while others at the farther end of the row are "shaken out" and ready for cleaning. The small core referred to above is here seen with the lifting handles in place, standing beside the drag half of the mould appearing in the foreground.

Fig. 65 shows a close-up view of the distant end of the row of moulds shown in the preceding view. The sand has been shaken from the mould and the castings appear as they are before being sent to the chipping and cleaning room.

The remarkable production obtained by the use of moulding machines on this casting is exceptional, as eight men produced 102 moulds per day, the cope and drag being made on different machines. The best results obtained under former conditions was the production by eight men of 16 moulds per day.

It should be noted also that the production from the hand-ramming method resulted in a scrap loss of 30%, while the scrap loss from the moulds made on the Roli-Over Jolt-Moulding Machine was less than 10%.



Fig. 66

A 42" x 60" Plain Jolt-Moulding Machine having a jolting capacity of 7,000 pounds.

CHAPTER VI

Plain Jolt-Moulding Machines.

In the early development of the jolt-ramming method of moulding, the experiments were made on the machine now known as the Plain Jolt-Moulding Machine. These early experiments extended over a period of about fifteen years, finally resulting in a machine that is highly satisfactory for producing a large variety of castings. The Plain Jolt-Moulding Machines are used largely in the jobbing foundries which produce a large variety of many different sizes of castings, as well as in those manufacturing establishments which operate a foundry as a part of their plant, producing only the castings used for their requirements.

The foundry has been retarded somewhat in the use of moulding machines, because of the difficulty experienced in attempting to use the patterns which the patternmaker or the manufacturer sends to the foundry for its use. It is an unfortunate fact that neither the manufacturer nor the patternmaker is interested enough in the progress of the foundry to inquire as to whether or not the moulds are to be made on a moulding machine. Instead, in a large number of instances, the patterns are made without any consideration whatsoever being given as to how the moulds are to be produced in the foundry and, therefore, are usually made in a manner such as would require their being moulded by hand on the bench or moulding floor.

Inquiry by the patternmaker as to how the patterns are to be used would encourage the foundryman to equip his plant with machines; and, likewise, if inquiry by the patternmaker were made of the manufacturer, as to how the pattern should be made, pointing out the fact that if made to be used for hand moulding the cost of his castings would be higher than if the pattern were made to be moulded on a machine, such an inquiry would immediately create a desire in the mind of the manufacturer to know more about the possible saving in the cost of castings, and investigation would be started which would eventually

lead to his issuing an order to his patternmaker to make all his patterns so that they could be used on moulding machines. This spirit of co-operation would be beneficial; experience has demonstrated the fact that patterns can be made for machine moulding in a manner more substantial and at a less cost than when made for hand-ramming methods.

The general use of the Plain Jolt-Moulding Machine in the plants above mentioned is due largely to the fact that it is possible to produce a jolt-rammed mould from the old-style patterns furnished the foundry by the customer, with less expense to the foundry than mounting the pattern on a pattern plate in order to produce the mould. In many foundries, in order to jolt-ram the pattern that has been furnished them for hand-ramming, it is the practice to use the Plain Jolt-Moulding Machine for jolt-ramming the drag only, in which case the pattern, if a flat back or split pattern, is placed upon the table of the machine without either bottom board or clamps; the flask is then set over the pattern and filled with sand, and, when filled, holds the pattern in place while the mould is being jolt-rammed by machine power. The bottom board is then placed on the drag, after which it is rolled over and placed on the floor and the cope hand-rammed in the usual method.

Other foundrymen first determine the range of flask sizes that is necessary in which to produce the output of their plant, and then provide several plates for the different sizes of flasks determined upon. These plates are provided with permanent center lines and other locating marks which make it a simple matter to mount the pattern that is furnished them by the customer. By this method it is possible to produce at the same time several castings of different sizes and shapes in the same mould.

The results obtained from the use of the Plain Jolt-Moulding Machines in the plants above mentioned, were satisfactory and in advance of results that had previously been obtained, nevertheless, an analysis of the work performed by the Plain Jolt Machine shows that there is a saving of only about 50% of the moulders' time in producing the mould, depending, of course, upon the manner in which the patterns are mounted. However,

it is evident that the Plain Jolt-Moulding Machine can only save the actual ramming time of the mould, as the rolling over of the mould and the drawing of the pattern must still be accomplished by a highly skilled artisan. The drawing of the pattern is a delicate operation as any unsteadiness of the moulder will break down the delicate projections of the sand, and it is rarely, if ever, that the pattern, regardless of size, is withdrawn from the sand in such a manner as to leave the mould perfect; in most instances the sand is broken down in many places, which must be mended; this again requires exceptional skill, and rarely, if ever, does the mended mould produce a smooth casting. The mending of the mould, in a large majority of cases, is so common among moulders, that even if the pattern is withdrawn from the mould without breaking the sand, the mending of the mould having become a fixed habit, the moulder immediately proceeds to use the trowel and slick tools to dress the mould with the same care that would be required if the mould actually needed mending.

The construction of the Plain Jolt-Moulding Machine is comparatively simple, in fact the simplest of the many different kinds of moulding machines in use. While the machines are of apparently simple construction, nevertheless the fact remains that in order to secure a machine that will produce the proper results, and give service over a period of years, thought should be given in the selection to secure a machine that not only has the above features, but in addition will be economical in operation both in point of the amount of air and oil consumed, and the care required to keep the machine in operating condition.

It is important that the design of a machine that will fulfill the above requirements should be one in which the working parts are fully protected and of ample size to reduce the wear to a minimum. The cylinder diameter and length on the Plain Jolt-Moulding Machine should be given careful consideration and made proportional to the table size, in order to secure a machine that will pack sand properly. The importance of this feature cannot be overestimated, as it is obvious that with the machine having a short piston, it would be difficult to secure the proper blow to produce a rapid packing of the sand, as the amount of working

clearance between the bore of the cylinder and the diameter of the piston would, with the short piston, be multiplied many times at the extreme edge of the table. Such a machine very often produces, when moulding, in addition to the jolting blow, because of the clearance referred to between the cylinder and piston, a side blow so pronounced that it causes a shaking of the sand, which is very detrimental to its packing and tends to loosen rather than to quickly and properly ram the mould.

In years past, considerable was said regarding the merits of the bottom or center-strike machine, as compared with the top-strike machine, in which a large area of the table contacts with the base of the machine. Both styles of machines are producing moulds satisfactorily. While much can be said as to the merits of the two different types of machines, nevertheless these points are largely a matter of individual choice and preference, based upon the conclusions arrived at after becoming familiar with the results obtained from each of the different types. It should be pointed out, however, that the center-strike machine is one that produces a sudden reversal of the action of the falling parts, by the contacting with the anvil of a single surface of a small and yet sufficient area, and without an additional side motion to the moving parts; therefore, the sudden reversal of the machine, with the absence of a side motion, has a decided advantage in the rapid packing of the sand. The top-strike machine, which is usually made with a short piston and cylinder, because of the excessive strains caused by uneven loading on the table, produces rapid wear at the top of the cylinder and piston, which permits one side of the table to be in advance of the other side; the lower side of the table contacting first with the anvil produces a slap-like motion of the table, which, of course, sets up a shaking action in the packing sand, resulting in its requiring a longer time in which to completely ram the mould.

In order to produce an economical operation by the consumption of the smallest amount of air, it is well to examine critically the many different styles of Plain Jolt-Moulding Machines on the market. It is essential, in order to conserve the compressed air, that there be some means of controlling the

amount used, and also to shut off the inlet port of the machine during the exhaust stroke. If the air inlet is permitted to remain open during the exhaust stroke, a large amount of air is uselessly consumed by its blowing through the machine and into the exhaust.

While the jolt-ramming of a mould is a comparatively simple operation, yet considerable difficulty, in years past, has been encountered in the ramming of the moulds required in foundries producing castings from various metals.

The stroke required on Jolt-Moulding Machines that will economically and properly pack the sand of a steel casting mould, varies considerably from the stroke that is required to produce the mould into which is to be poured iron, brass or aluminum. In addition to the varying degree of hardness required in the mould, there are the elements produced by the use of the different grades of sand that are required in making the mould. To meet these varying conditions, it is well to have a machine the stroke of which can be adjusted to suit the requirements. The stroke, however, when once set for a particular foundry, rarely, if ever, requires further adjustment.

The adjustable feature of the stroke, which, of course, is obtained by the adjusting of the valve on the machine, is, many times, a decided advantage when difficult copes are to be made, which in many instances require a long stroke with a sharp, quick blow, while in the majority of moulds a shorter stroke, with lesser blow, will accomplish the results in the same time and without the same amount of detrimental action to the machine and pattern equipment.

In the early years of moulding machine operation, there existed in the minds of foundrymen the feeling that the machine, when once installed in the foundry, should operate and give entire satisfaction without being cared for by a competent mechanic. They did not realize the importance of keeping the machine properly oiled and free from sand obstruction. There should be in every foundry operating moulding machines a mechanic with sufficient mechanical intelligence to properly inspect and keep the machine in proper working condition.

The pattern equipment, flask, etc., is another important item that has not been given the proper amount of consideration. Experience has thoroughly demonstrated that in order to secure the best results, proper attention must be given to equipping the machine with patterns, flasks, bottom boards, etc. In equipping the machine with patterns, exceptional care should be exercised to firmly secure the pattern to the pattern-plate, and patterns having a large flat surface should be thoroughly and strongly supported from the bottom in order to remove the possibility of a springing action taking place in the pattern when the mould is being rammed. If the pattern is not properly supported and a springing action takes place, the mould produced will be full of cracks, and if a cope, will drop out when the flask is being handled.

The flasks also should be examined to see that they are rigid and of sufficient strength to prevent a springing action. The best results have been produced by the flasks that are cast solid in one piece. This is especially important when designing the cope half of the flask, and yet in some instances it is difficult to cast integral the flask and the proper bars for supporting the sand. If it is found necessary to make use of a separate bar, it should be secured to the flask by means of rivets, or tightly fitted bolts, as a loose bar will prevent the making of a satisfactorily rammed mould.

The above description of the equipment necessary in jolt-ramming applies not only to this particular chapter, but to all machines which make use of the jolt-ramming principle.

The working action of the Jolt-Moulding Machine is such as to cause a vibration throughout its different parts. This vibration, of course, becomes exaggerated when the machine is made up of many different castings. It has been exceedingly difficult to bolt together the different parts of a machine in a manner that will withstand the severe vibration produced in the bolted members. Where bolts are used, it has been found that the best type of lock washers are not sufficiently strong and rigid to hold the parts in place and, therefore, if bolts are a necessity, a method should be used that will absolutely prevent the loosen-

ing of the bolt ; for, if only a few bolts loosen, and the remaining bolts remain tight, an exceptional strain is produced on those that are holding, thereby causing a breakage of the casting or of the bolts.

Modern requirement is rapidly demanding a machine designed with as few parts as possible, eliminating the bolted construction, and in its place a design that will withstand the severe vibration caused by the jolting action.

Since the action of the Jolt Machine in operation is severe and very much like the same action as is used in breaking up scrap iron for the cupola, it is obvious that a machine that will withstand the repeated blows of jolt-ramming should be of a massive and heavy construction with as much of the blow as is possible prevented from reaching the different parts.

The castings shown on the following pages were made on a Plain Jolt-Moulding Machine. The increased production of the Plain Jolt-Moulding Machine over hand moulding justifies its installation. Nevertheless, where there is available a Roll-Over Jolt-Moulding Machine, a still greater saving can be produced, provided there are several castings to be made from the pattern. It has been demonstrated that the Roll-Over Machine can be used advantageously for a day's production of 96 moulds made from 16 different patterns.

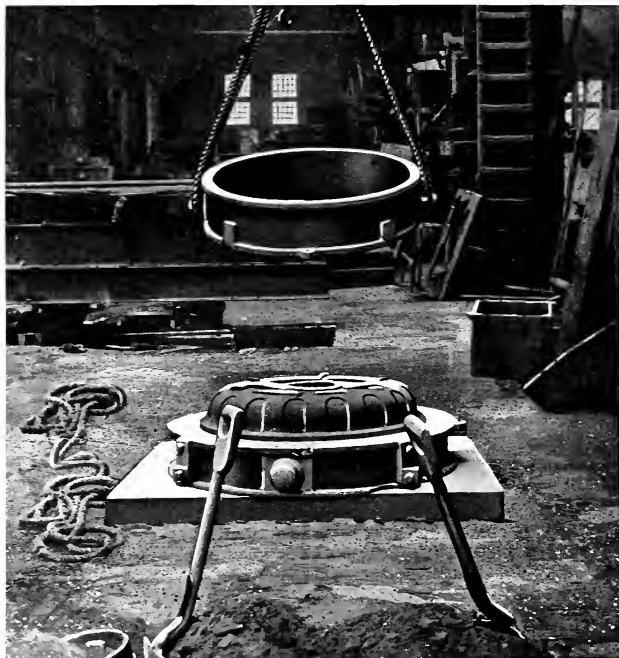
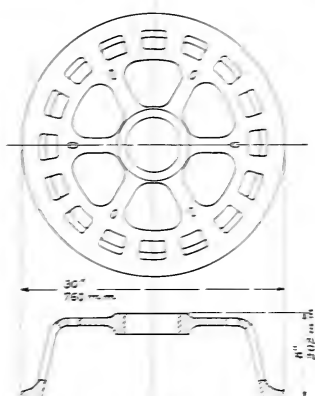

Fig. 67. Generator End Frame made on a 54"x66" Plain
Jolt-Moulding Machine.

The cope and the drag half of the mould are both made on this machine.

Generator End Frame Casting.



Weight 210 pounds.

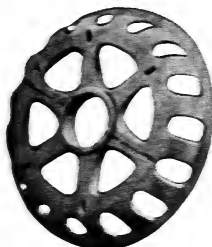

Fig. 68

Production based on making both the cope and the drag half of the mould on the same machine.

PRODUCTION

Method of Moulding	Nr. Men	Hours	Gran. Moulds	% Increase
Without Machine	2	9	6
Cope—54" x 66" Plain Jolt.....				
Drag—54" x 66" Plain Jolt.....	2	9	12	100%

A Roll-Over Jolt-Moulding Machine would give an increase in production of from 400 to 500%.

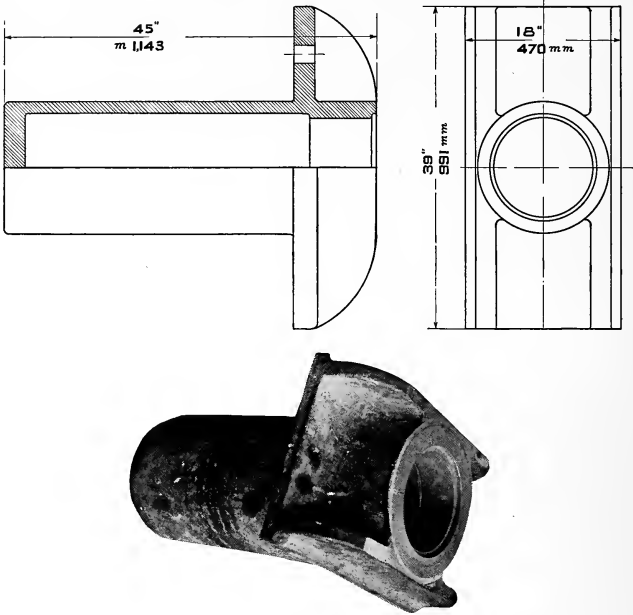

Fig. 69

Steel Casting Press Cylinder. Weight 610 pounds.

Production based on making both the cope and the drag half of the mould on the same machine.

PRODUCTION

Method of Moulding	No. Men	Hours	Quan. Moulds	% Increase
Without Machine	4	9	2
Cope—54" x 66" Plain Jolt.....				
Drag—54" x 66" Plain Jolt.....	4	9	5	150%

A Roll-Over Jolt-Moulding Machine would give an increase in production of from 300 to 400%.

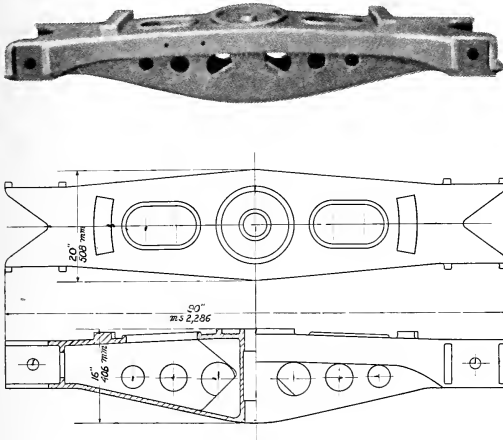

Fig. 70

Railway Truck Bolster—Steel Casting. Weight 430 pounds.

Production based on making both the cope and the drag half of the mould on the same machine.

PRODUCTION

Method of Moulding	No. Men	Hours	Quan. Moulds	% Increase
Without Machine	5	9	12
Cope—42" x 97" Plain Jolt.....	5	9	30	150%
Drag—42" x 97" Plain Jolt.....				

A Roll-Over Jolt-Moulding Machine would give an increase in production of from 300 to 400%.

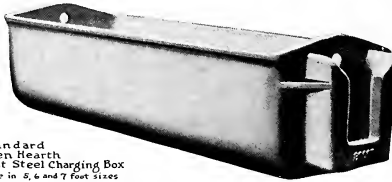
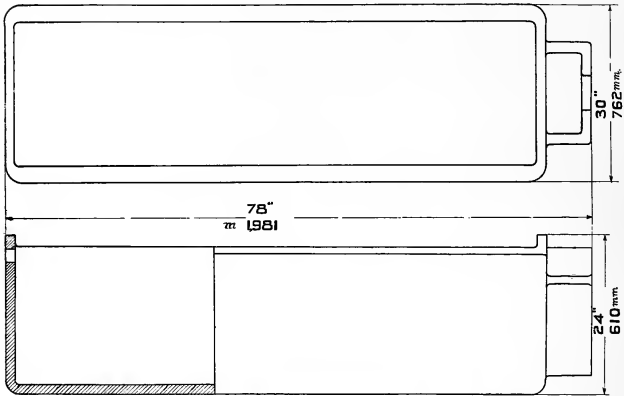

Standard
Open Hearth
Cast Steel Charging Box
Made in 5, 6 and 7 foot sizes

The Wellman-Seaver-Morgan Co., Cleveland, Ohio

Fig. 71

Weight of casting 1210 pounds

Production based on making both the cope and the drag half of the mould on the same machine.

PRODUCTION

Method of Moulding	No. Men	Hours	Quan. Moulds	% Increase
Without Machine	4	9	2
Cope—54" x 66" Plain Jolt.....	4	9	6	200%
Drag—54" x 66" Plain Jolt.....				

A Roll-Over Jolt-Moulding Machine would give an increase in production of from 300 to 400%.

Base and Cylinder Cast Integral.

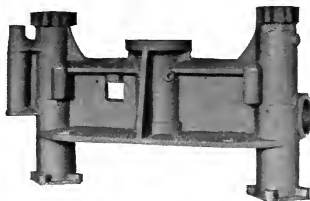

Weight 1700 pounds.

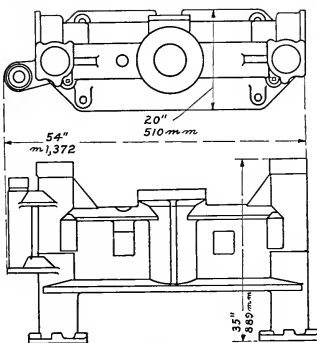

Fig. 72

Production based on making both the cope and the drag half of the mould on the same machine.

PRODUCTION

Method of Moulding	No. Men	Hours	Quan. Moulds	% Increase
Without Machine	4	9	2
Cope—54" x 66" Plain Jolt.....	4	9	4	100%
Drag—54" x 66" Plain Jolt.....	4	9	4	100%

A Roll-Over Jolt-Moulding Machine would give an increase in production of from 500 to 600%.

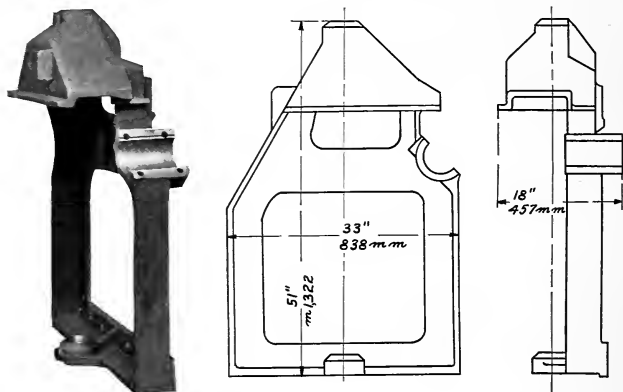

Fig. 73. Side Frame Casting.

Weight 800 pounds.

Production based on making both the cope and the drag half of the mould on the same machine.

PRODUCTION

Method of Moulding	No. Men	Hours	Quan. Moulds	% Increase
Without Machine	4	9	2
Cope—54" x 66" Plain Jolt.....	4	9	4	100%
Drag—54" x 66" Plain Jolt.....	4	9	4	100%

A Roll-Over Jolt-Moulding Machine would give an increase in production of from 400 to 500%.

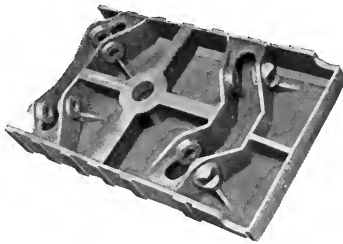
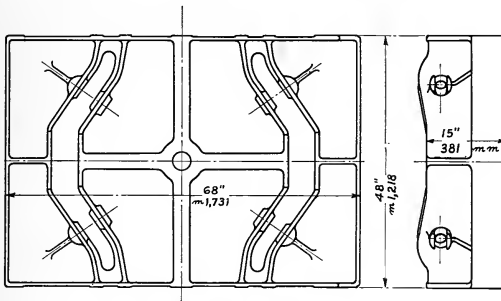

Fig. 74

Truck Center Casting for Locomotive Crane. Weight of casting 1680 pounds.

Production based on making both the cope and the drag half of the mould on the same machine.

PRODUCTION

Method of Moulding	No. Men	Hours	Quan. Moulds	% Increase
Without Machine	3	9	1
Cope—54" x 66" Plain Jolt.....	3	9	2	100%
Drag—54" x 66" Plain Jolt.....				

A Roll-Over Jolt-Moulding Machine would give an increase in production of from 400 to 500%.

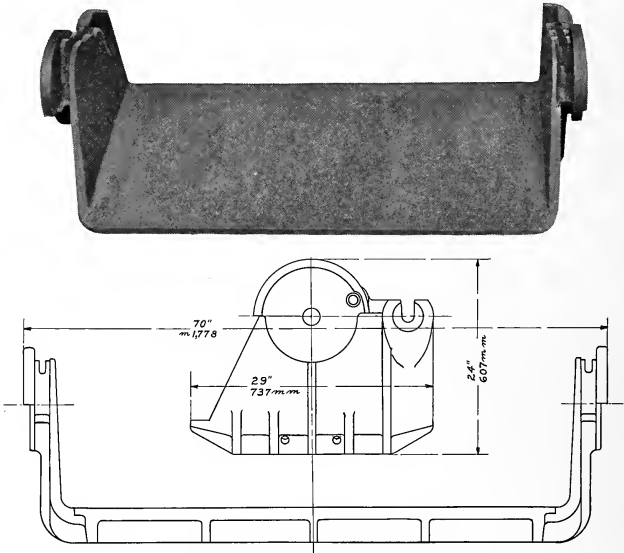

Fig. 75. Large and Difficult Table Casting. Weight 1500 pounds.

Production based on making both the cope and the drag half of the mould on the same machine.

PRODUCTION

Method of Moulding	No. Men	Hours	Quan. Moulds	% Increase
Without Machine	3	9	1
Cope—54" x 66" Plain Jolt.....	3	9	2	100%
Drag—54" x 66" Plain Jolt.....				

A Roll-Over Jolt-Moulding Machine would give an increase in production of from 500 to 600%.



Fig. 76. A floor of Generator End Frame Moulds made on the Plain Jolt Machine shown in the foreground, at the plant of
THE WESTINGHOUSE ELECTRIC & MFG. CO.
Cleveland, Ohio, U. S. A.

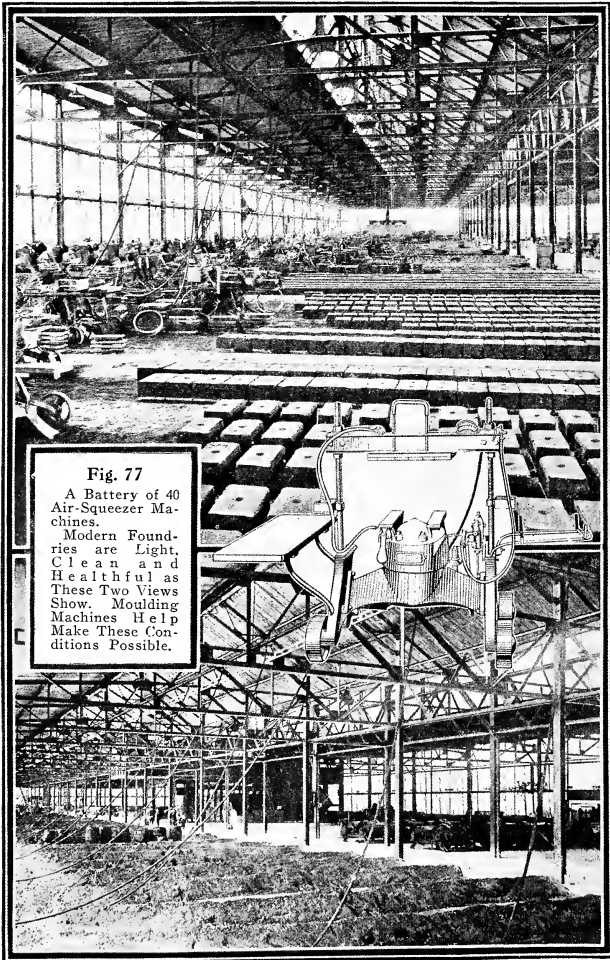

CHAPTER VII

Air-Operated Squeezer Moulding Machine.

Primarily the air-operated squeezer type of moulding machine was designed to replace the old laborious hand method of bench-moulding for light work. The question of producing, rapidly and economically, large numbers of small castings from one pattern, is one that cannot be lightly treated; this fact is evident from the varied and interesting devices designed to facilitate this class of foundry work. The first development in the art produced a single pattern with its match of green sand; next on a single gate, then the improving of the green sand match by substitution of fire-clay or oil-sand for the delicate green sand; further development produced a match board similar to the modern match plate. Then various plates were first used for hand-ramming on the bench, but soon a squeezer type of moulding machine, crude in design and hand-operated, came into favor and was extensively used throughout the United States of America.

The original type of air-operated squeezer was designed purely and simply a mould-squeezing machine, as its name implies, and this type is still doing efficient and rapid work in its own particular line. With the plain squeezer type of machine the most common and extensively used form of pattern is that of the match-plate type, although the vibrator-frame and oil-sand match are also frequently used.

Combination Jolt Squeezer

Later it was found that a great many patterns belonged in the squeezer class of work, as the weight of the casting was such as could be produced by squeezer-moulding, but the depth of the mould prevented the use of this type of machine, as the squeezing failed to pack the sand properly at the bottom of the pattern and next to the match plate; to meet this difficulty a machine was designed that embodies the principles of both the squeezer and the jolt machines. This machine is in appearance

the same as a standard air-operated squeezer, but is called a Jolt-Squeezer Moulding Machine. It has mounted within the large squeezer piston a small jolt cylinder in which operates the jolt-piston carrying the table of the machine, usually cast integral with the piston. No changes are required to use either feature of this dual machine, hence a deep mould may be jolted to pack a deep recess, by a slight pressure of the knee against an air inlet valve. A few jolts of the mould settles and begins the packing of the sand in the recess of the pattern and the corners of the flask, after which the mould is squeezed in the usual manner, packing the remainder of the sand in the flask. This feature of double utility is also an effective means of preventing what is

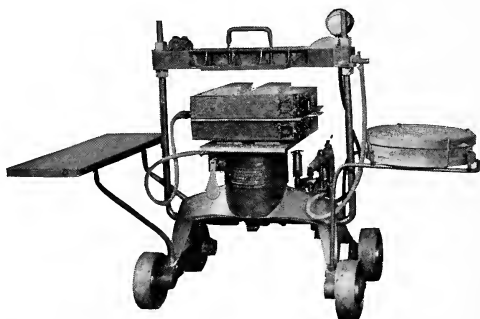

Fig. 78. Air-Operated Squeezer Moulding Machine with Mould in Position for Squeezing.

known as "ram-off," an annoyance caused by the sand, after being tucked against the side of the pattern or into a depression, being pushed away again by the squeezing action of the Plain Squeezer Machine. These machines are used not only in the standard design, but also with other special attachments, for example, a stripping or pattern drawing device, and when so equipped is commonly known as a Split Pattern Machine. These machines are used for a heavier class of work, such as flywheels for small gas engines, valve and pipe fittings, gears, etc. They are usually operated in pairs; the drag pattern mounted on one machine, and

the cope pattern on the other. The addition of this device does not in any way interfere with the usual operation of the machine as a standard squeezer. It is also used extensively for such patterns as require stooling.

The standard types of Air-Operated Squeezer Moulding Machines are usually mounted on wheels. The advantage in the use of this construction is that, if desired, the machine can be moved along the side of the sand heap on the working floor—or can be permanently located, and the sand piled in a heap beside it. Even though the machine is permanently located, there is still a decided advantage in the use of the wheels, as it allows the moulder to shovel the sand which falls underneath the machine while in operation, without his shovel coming in contact with the lower part or the body of the machine.

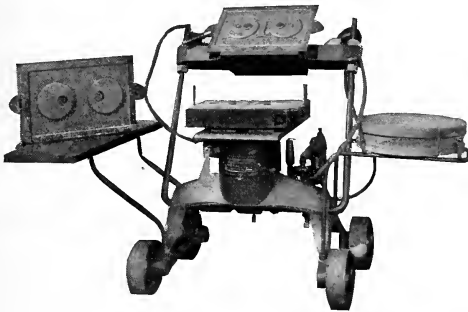

Fig. 79. Air-Operated Squeezer Moulding Machine with Pattern
Drawn from the Mould.

Sand Straddler Squeezer

Another style of air-operated squeezer is that known as the Sand Straddler, mounted on wheels having a wide span. This machine is designed to straddle or span the sand heap, the sand being piled in long rows, but shorter than the length of the moulding floor, to permit placing the first moulds and allow working place. As the floor is filled with moulds the machine is pushed ahead, the sand being taken from beneath the machine.

Description

In air-operated squeezing machines of any size or type, should be found incorporated the following principles: All working parts should be fully enclosed or shielded against sand and grit; the place for moulding sand is either in the mould or on the floor, hence the contours of the exposed members of the machine, as far as possible, should be of the inverted "V" design so as to shed the falling sand; simplicity of operation is essential to its proper working under the conditions usually existing in the foundries; pistons should be provided with cast-iron piston rings and proper oiling facilities; the strain rods carrying the pressure head should be adjustable for height to meet the conditions existing due to varying height of flask used; the pressure head and strain rods should be counterbalanced; operating valve should be in convenient location at right of operator and below the working position of the table; this operating valve should be automatically locked except when pressure head is in squeezing position; there should be a release pop valve releasing pressure in the cylinder

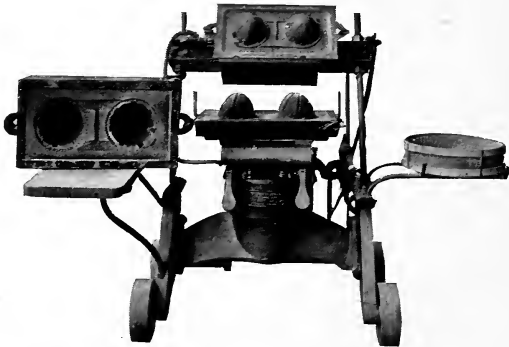

Fig. 80. An Air-Operated Jolt-Squeezer Moulding Machine.

when mould has been squeezed to a predetermined density, pressure gauge, blow valve, riddle bracket, and a shelf for holding the cope half of the mould while drawing pattern from the drag half which is still left on the table of the machine. These features make a self-contained and independent unit.

OPERATION

A description of the operation of the squeezer machine may be found in Chapter VIII, Pages 109 and 112.



Fig. 81. A Day's Work in the Malleable Foundry of The Westinghouse Electric & Mfg. Co., Cleveland, Ohio, U. S. A.

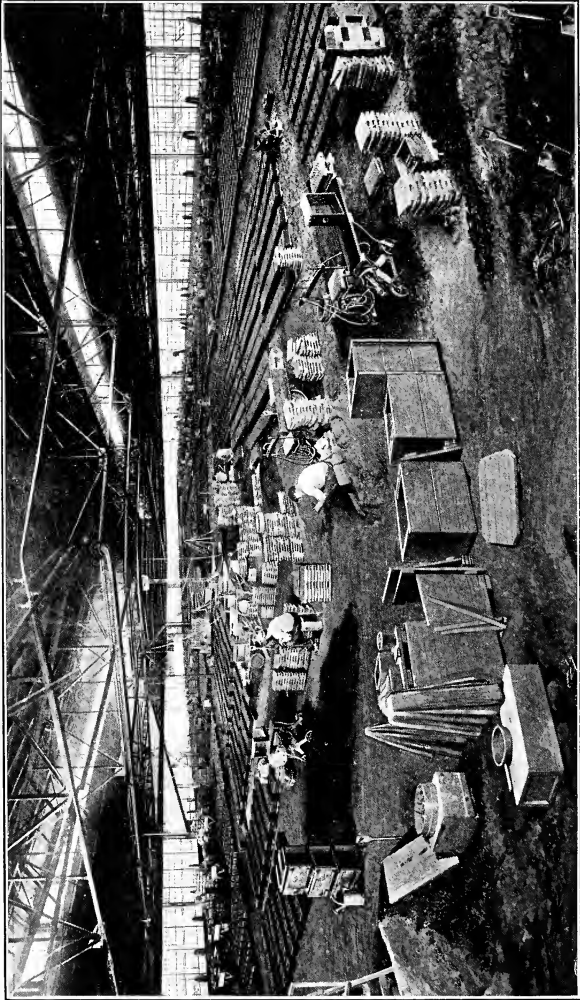

Fig. 82. An Every Day Occurrence at The Federal Foundry Co., Indianapolis, Ind., U. S. A.

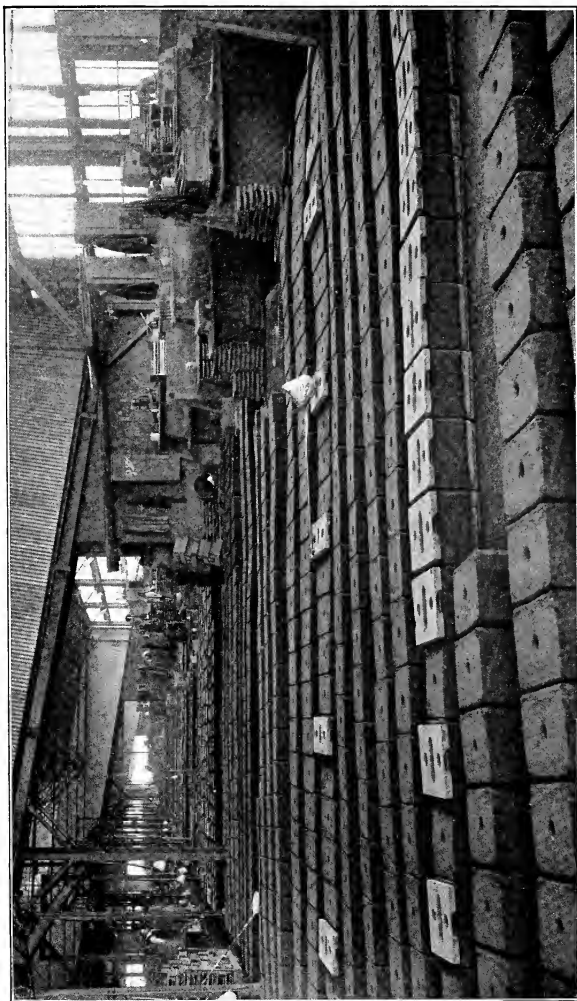

Fig. 83. Interior View of The Best Foundry Co., Bedford, Ohio, U. S. A.



Fig. 84. Foundry Interior of The Universal Winding Co., Providence, R. I., U. S. A.

CHAPTER VIII

Pattern Equipment.

Patterns are divided into two general classes—wood and metal. The material used in the making of a metal pattern may be either brass, aluminum, white metal or iron, depending, of course, upon the size and whether or not the pattern in moulding is to be handled or fastened to the table of the machine. Metal patterns are made from master patterns, which for machine mounting should be provided with the necessary ribs to reinforce any weak portion of the pattern. It is well also, where possible, to provide suitable lugs or bosses (preferably inside the profile of the pattern) for fastening the pattern to the pattern plate, altho in some instances the pattern and pattern-plate are cast integral. The necessity for rigidity of construction cannot be too strongly emphasized in the making and mounting of patterns that are to be used for jolt machine-moulding, as the pattern that is so made as to permit a springlike action to take place while the machine is being jolted, will cause a vibration that will prove very detrimental to the proper packing of the sand, and if such a pattern is used, the mould will be full of cracks or other imperfections. Therefore, considerable stress must be laid upon the importance of properly reinforcing the flat surfaces of the pattern in such a manner as to prevent vibration.

The pattern should not be designed until the style of the moulding machine for producing the mould has been determined, after which consideration should be given to the proper size of flask. In determining the size of flask that should be used in connection with the moulding machine, it is well to keep in mind the fact that a machine-rammed mould, made in a suitable flask, does not require as large an amount of sand between the pattern and the flask as has been the common practice in the foundries making use of a more fragile type of flask or those making use of the ordinary wood flask.

It is well to point out the necessity of considering the advisability of producing the mould in a rectangular flask, i. e.,

whether or not the quantity of castings to be made from the pattern is such as would warrant the making of a flask of a special shape, following the outline of the pattern, commonly known as "cut" flasks.

Metal Patterns and Pattern Plates

As has been pointed out, when mounting patterns which are to be used on jolt-moulding machines, extreme care should be taken to see that the pattern is thoroughly reinforced and free from all possibility of a springing action taking place in the pattern itself while the mould is being jolted. Patterns for use on this type of machine, from which a large quantity of

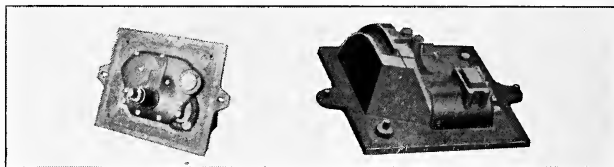

Fig. 85

Fig. 86

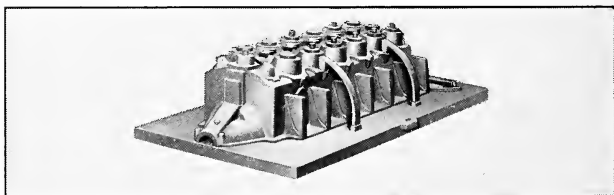

Fig. 87

castings is to be produced, are usually made of metal and mounted on iron plates. The thickness of the plates should not be decided until after determining the height they should be made, in order to conform to the moulding machine on which they are to be used. Where it is possible, they should be made deep and hollowed out in the back, also reinforced by ribs running in both directions, and, if the plate can be made of sufficient height, a hole should be provided on the sides, suitable

for attaching clamps for holding the bottom board and flask to the plate, while the mould is being rolled over.

Figures 85, 86, and 87 clearly illustrate the high state of attainment in the art of pattern-making. The patterns are of a design requiring the highest grade of workmanship, in order to produce the profiles which will match and maintain the uniformity of section that is required in this particular type of casting—the section in many cases being not more than $\frac{3}{16}$ " in thickness.

In Figure 107 is shown the cope and drag halves of a metal pattern mounted side by side upon the table of a Roll-Over Jolt-Moulding Machine. A careful study of this view will convince the reader that this style of operation is economical where the pattern is of a length to permit its being used in this manner.

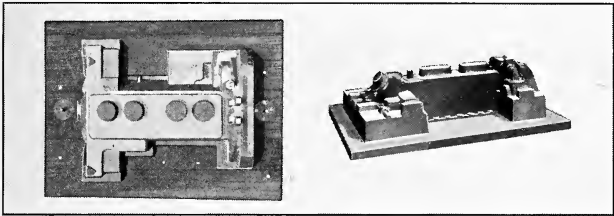

Fig. 88

Fig. 89

In the view here shown it will be noted that sufficient blocking has been provided below the pattern-plates to make the top of

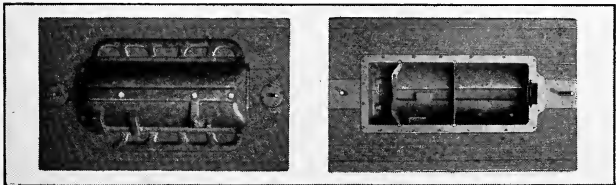

Fig. 90

Fig. 91

both cope and drag halves of the flask the same distance from the table of the machine.

Wood Patterns and Pattern Plates

Machine-moulding is so thoroughly a part of the automobile industry that very little comment is necessary upon the manner

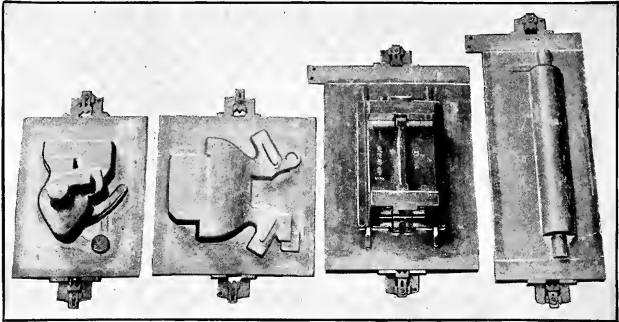

Fig. 92

in which patterns are made, and the views which show automobile castings are used only for the information of those other foundrymen who are not familiar with the progress that has been made in the automobile foundries. Therefore, in order to show the use of the jolt-moulding machine in plants other than the specialty foundries, and the gain to be made from their universal use in foundries, illustrations are shown and a full description given of the method of making and mounting wood patterns upon wood plates; also the practice in use in some foundries

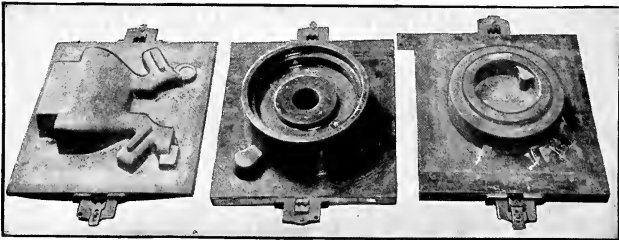

Fig. 93

where a universal plate is used and patterns of all shapes and sizes are mounted on the plate, in order to fill the standard size flask provided for the standard pattern-plates that have been adopted.

Figures 88, 89, 90 and 91 show several patterns mounted on wooden plates. They also show the condition of the patterns after hundreds of castings have been made. These patterns were used on a medium size Roll-Over Jolt-Moulding Machine.

The group of patterns shown in Figures 92 and 93 is illustrative of the best method of making patterns for use on jolt-moulding machines. These patterns were originally laid out and made for jolt-moulding; the patterns and plates have been constructed together (the patterns being built solidly into the plate) making both the plate and the pattern more durable than when made separately and fastened together by means of bolts or screws. It has been fully demonstrated by cost records that a pattern of this description can be made at a cost not exceeding that of making the same pattern for floor moulding.

Jobbing foundries are confronted with the necessity of making use of patterns which the customer sends them and which are usually made for floor ramming. If the foundryman desires to make the moulds on a moulding machine, it is necessary to alter the pattern, or at least to provide plates upon which he can mount the pattern. This situation has been met in some foundries by the use of a master pattern-plate, made from either steel or wood; if made of wood, they are usually edged with metal cleats upon which the flask is to rest, and which also protects the wooden plate. These master plates are provided with center lines which make it a simple matter to align the patterns that are placed thereon.

From the views shown in Figures 94, 95, 96 and 97 it will be seen that there can be mounted on the plates many different shapes, styles and sizes of patterns, the object being to always fill the plate with patterns in order to make use of all the available space in the flask. The views of the plates shown in Figures 96 and 97 especially emphasize this possibility as there are several different styles of pattern poured from one gate. The pat-

terns shown in these figures, with the exception of the gear, are so-called "flat back" patterns, requiring no part of the pattern in the cope. By referring to Figure 97 it will be noted that the cope-plate, standing alongside the drag-plate, is provided with a depression that aligns with the gear shown on the drag-plate, this

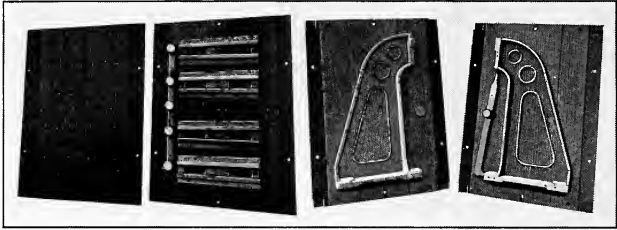

Fig. 94

Fig. 95

depression produces the proper shaped cope half of the mould for the gear. The particular plates shown in these four figures were made to be used in connection with a Roll-Over Jolt-Moulding Machine.

Comparison of Machine and Floor Patterns

In order to more clearly bring before the reader the possibility of the great saving to be made, by originally making the patterns to be used for machine moulding, there are shown in

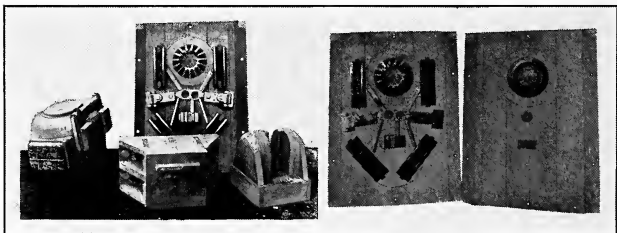

Fig. 96

Fig. 97

the following views, the casting to be produced, the pattern as it was made for use on the moulding floor, and also as it was

later mounted to be used on either the Plain-Jolt or Roll-Over Jolt-Moulding Machine.

Figure 98 and 99 (combined) shows a casting difficult to make, and the manner in which the pattern was made for hand-ramming on the moulding floor. Observe the "stop-off" piece used in order to hold the shape of the pattern while the mould was being rammed, which was difficult to do regardless of the stiffening member.

Fig. 100 shows the manner in which a new pattern was later mounted on pattern-plates for use on jolt-moulding machines. The difficulty experienced in the producing of a casting straight and true to pattern was entirely eliminated by the use of the pattern-plates.

Figs. 101 and 103 show large and difficult castings.

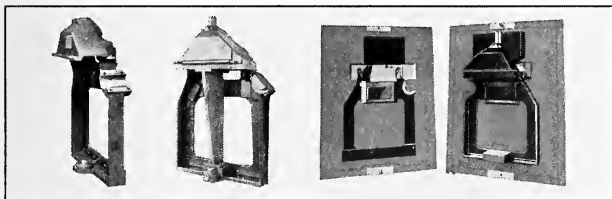

Fig 98

Fig. 99

Fig. 100

Figs. 102 and 104 show patterns as they were originally made for use, either on the floor or on jolt-moulding machines. However, it was only possible to make the drag half of the mould on the machine when using the patterns without being mounted on pattern-plates. This was accomplished by placing the patterns flat on the table of the machine and after jolt-ramming the drag half, the flask and pattern were rolled over and placed on the foundry floor, and the cope half of the pattern rammed by hand in the usual way.

Fig. 105 is still another view, which again emphasizes the advantage to be gained by mounting the patterns on pattern-plates, especially fragile patterns.

In the early days of machine-moulding there was developed

a method of mounting patterns known as "shell patterns." Such patterns when mounted for machine use were usually made for the production of castings in large quantities, the cope and the drag being mounted on separate machines—usually the drag on a roll-over type of machine, and the cope on a stripping-plate

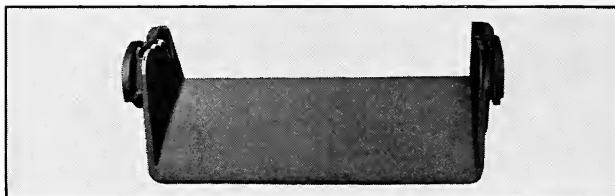

Fig. 101

machine. The method devised was such as to make use of the shell pattern for either the cope or drag-plate.

The views shown in Fig. 106 are of the cope and drag patterns mounted on a stripping-plate and roll-over machine respectively. The pattern here shown is a jacket of a hot water gas heater with the shell varying in thickness from $\frac{1}{8}$ " to $\frac{3}{16}$ ". The shell pattern was used for the cope-plate, while a white metal match was made from the shell pattern, and used for the drag-plate. Foundries producing stove castings generally make use of this method of pattern-mounting, the details of which are well known to the industry.

Match Plates and Vibrator Frames

There are several different methods in use for the making and mounting of patterns to be used in connection with air-operated squeezer machines.



Fig. 102

It is, of course, necessary, when producing match-plate patterns, to first provide a set of gate patterns, from which is made the match-plate, provided it is to be of cast material, or, if the

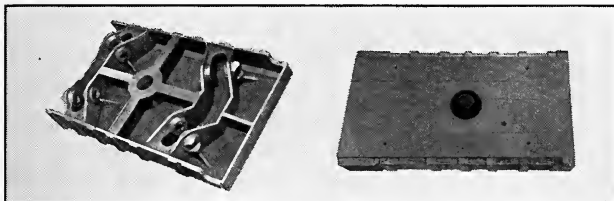

Fig. 103

Fig. 104

parting lines of the patterns are uniform, it is possible to use a standard flat plate of either steel or aluminum, in which case the individual patterns may be machined separately and properly mounted on both sides of the plate.

If the match-plate is to be cast, either because this method is more economical, or because the match-plate has an uneven parting line, the method of procedure is as follows:

A master wood pattern is prepared of the desired casting, making allowance for the shrinking of the match-plate material in addition to the shrinking of the metal from which the casting is to be made. Precaution should be used, when making this pattern, to see that the pattern is perfectly smooth and free from back draft. A mould is made from this pattern in

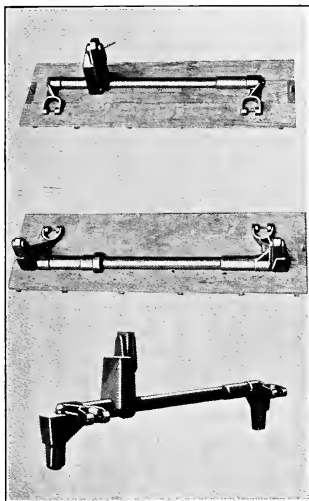

Fig. 105

the usual way, using a flask sufficiently large to contain the size of the plate desired. The mould is then parted and strips of wood the thickness desired for the plate, about $\frac{1}{4}$ " , are laid on the drag; the outer edges of these strips representing the extreme edges of the finished plate. When it is desired to have the guide pin ears cast integral with the plate, the strips of wood represent-

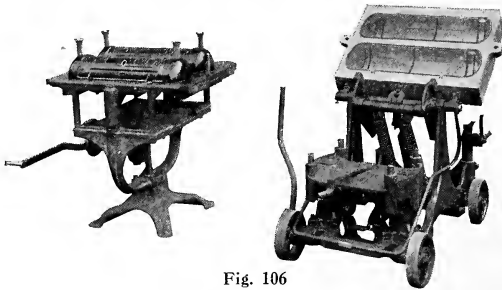

Fig. 106

ing the ends of the plate must have their outer edges shaped to conform to that of the desired ear. A place should likewise be provided for attaching the vibrator.

A new parting must be built around and outside of the strips of wood, to the same height as the upper surface of the strips, in order to separate the mould after the wood strips have been removed. The mould is then closed and poured in the usual manner.

Match-plates of this type are cast from either brass, white metal or aluminum, and if proper care has been exercised in making the mould, they require very little finishing or scraping; a brushing with a wire scratch brush and the removal of any fins is usually all the finish required. After the flask pin guides and vibrator have been attached to it, the plate is ready for use.



Fig. 107

Match-plates of this description are shown in Figures 108 and 109, together with the moulds ready for closing and pouring.

Another variety of match-plate, easily constructed when the parting line of the mould is a flat surface, is made by attaching the halves of the pattern to opposite sides of a metal plate. A very satisfactory method of doing this is to procure a metal

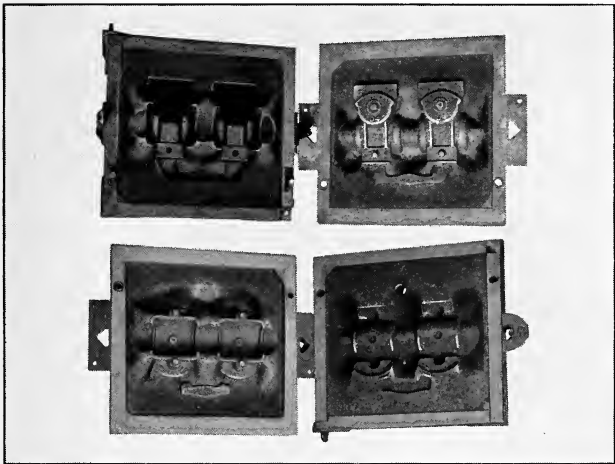

Fig. 108. Upper left—Cope-Mould; right—Cope side of plate.
Lower left—Drag side of plate; right—drag mould.

plate of steel or aluminum the size of the desired match-plate, not overlooking the ears for the guide pins. The halves of each pattern, which is of the split type and made of metal, are then clamped together, and two or more dowel pin holes drilled thru both parts. The drag portion of the pattern is located on the plate, together with the runner and gates; and, using the dowel pin holes in the pattern as guides, the same size holes are drilled thru the plate. The dowel pins can then be driven thru the drag pattern, the plate and the cope pattern. The halves of the pattern are now accurately aligned on opposite sides of the plate and may be secured to it by means of screws or pins. The match-

plate should then be provided with the proper flask pin guides, after which it is ready for the foundry. Figure 110 shows a pattern well suited to this form of match-plate.

The vibrator frame provides a satisfactory means of using solid metal patterns, or a gate of patterns, without a great amount of work being connected therewith. The vibrator frame and patterns are used in connection with a hard match. The frame

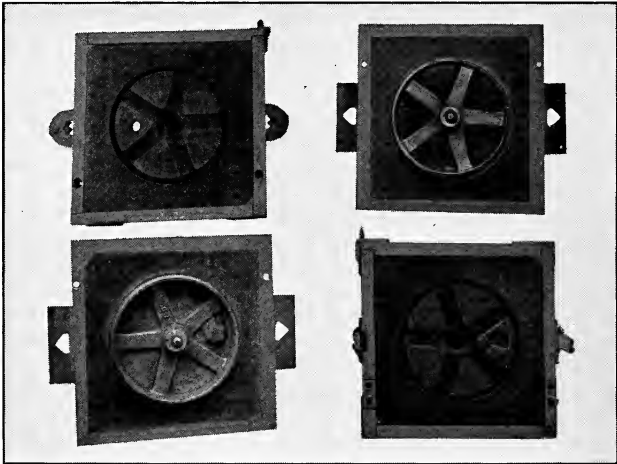

Fig. 109. Upper left—Cope mould; right—Cope side of plate.
Lower left—Drag side of plate; right—drag mould.

is made of either aluminum or cast iron, about $\frac{3}{8}$ " thick by 1" in width, the length and width of the frame being the same as the outside dimension of the flask with which the vibrator frame is to be used. The guide pin ears are cast integral with the frame, and then this frame is placed over the pattern, which is secured by means of brass metal strips about $\frac{1}{8}$ " in thickness, and extending along the parting line of the mould. This strip of metal is securely fastened to the pattern or gate of patterns and vibrator frame, as shown in Fig. 11. The hard match is made in the same manner in which a regular mould is made.

The material used in making the hard match varies, although the following formula has been found to give satisfaction: To eight parts by weight of boiled linseed oil, add by weight, one part of yellow oxide of lead. A sufficient amount of the mixture is added to new moulding sand (which should be baked to insure it being thoroughly dry) to make it the consistency of well tempered moulding sand. The vibrator frame is placed in the flask and the drag and cope rammed in green sand. The cope is then removed and replaced with a wood frame, previously prepared for containing the match preparation. The surface of the drag and the pattern are then dusted with suitable parting material, and a new cope rammed up in the match frame, using the match material. The surface of the match is then made even with the frame, and a bottom board secured in place with screws. The mould is

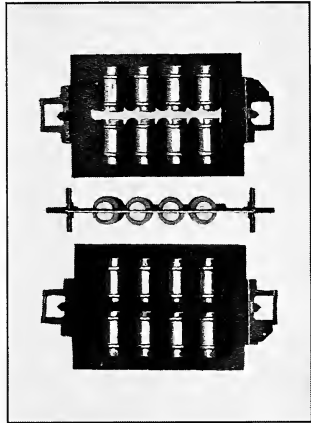

Fig. 110

next rolled over and the green-sand drag removed. The pattern can then be drawn and any portion of the match that has been injured by the drawing of the pattern can be repaired. The match should then be set aside in a warm place for about twelve hours and allowed to become hard and dry; shellac may be applied for the purpose of further water-proofing. A gate of patterns, suspended in a vibrator frame, together with the hard match and a mould made from the patterns, are shown in Fig. 111.

The gated pattern and hard match, shown in Fig. 112, are prepared for use by the simple process of making a hard match for the cope of the pattern, which is used in the same manner as the vibrator frame, except that no vibrator is used, the pattern being rapped thru the sprue as in bench moulding.

Using Match Plates and Vibrator Frames

To use a match-plate on an air-squeezer moulding machine requires the match-plate, a flask-parting compound, a tubular sprue cutter, a quantity of bottom boards, a cope board and the vibrator. The cope half of flask is placed on the table of the machine, and upon this the match-plate—the cope side being

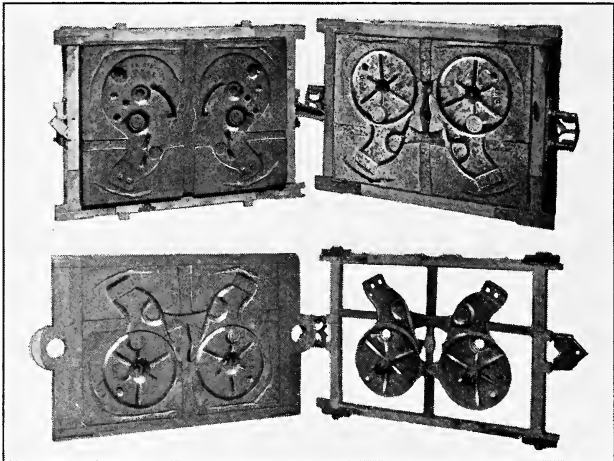

Fig. 111. Upper left—drag mould; right—cope mould. Lower left—hard sand match; right—pattern mounted in vibrator frame.

turned downward. The parting substance is then dusted over the drag side of the match-plate, and sufficient sand riddled into the flask to completely cover the pattern. Sand is then taken from the sand heap to fill the flask, and the flask "struck off," using the bottom board for a "strike," and the bottom board placed in position on the mould. The bottom board must be about $\frac{1}{8}$ " smaller all around than the inside of the flask. The mould must now be rolled over and the operation repeated to fill the cope flask. Instead of a bottom board, however, a cope board is used, which is similar to the bottom board, but has a

button secured to the face of it, serving to locate the position of the sprue. The pressure head is then drawn forward, the operating valve handle pressed down and held until the relief or "pop" valve operates. The squeezing is then complete. The pressure head is then pushed back and the cope board removed. The sprue is cut by means of a brass tube sprue cutter, at the point indicated by the impression of the button secured to the cope board. The

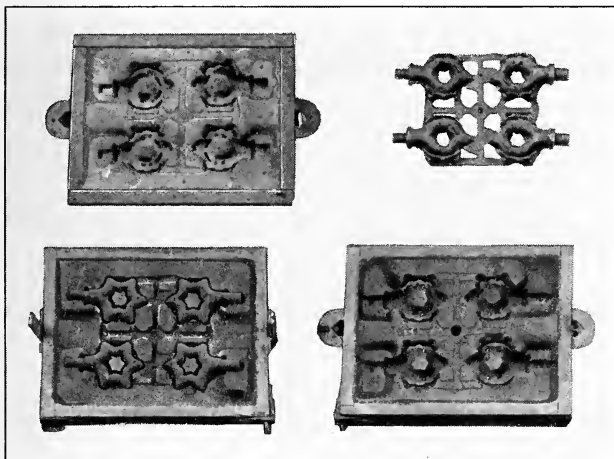

Fig. 112. Upper left—hard sand match; right—gated pattern.
Lower left—drag mould; right—cope mould.

vibrator is then started by the pressure of the knee on an air inlet valve, and the cope half drawn off and set on the shelf at the left side of the machine. The vibrator is again applied and the match-plate of patterns withdrawn from the drag half of the mould; the match-plate is then placed on the pressure head, and allowed to lean against the handle, which is covered with rubber in order to prevent marring of the patterns.

The vibrator frame type of pattern is moulded in a similar manner. The pattern, in its hard match, is placed on the table of the machine, the drag flask set in place, and the sand riddled

into the flask; it is then filled and struck off. The bottom board is then placed, and the mould is rolled over. The match is then removed and replaced by the cope flask. The pattern and the sand in the drag flask are dusted with parting compound, and the cope filled with sand, in the same manner as the drag. The cope board is placed on the top; the pressure head drawn into position, and the squeezing operation performed as before described. The cope board is then removed and the sprue cut. The pattern is vibrated again and drawn from the drag. The impressions of the strips holding the pattern in the

frame must be stopped off with sand, after which the mould is closed and placed on the pouring floor.

The ordinary gated pattern is handled in the same manner as the vibrator frame, except—there being no means of attaching a vibrator to the pattern—it is rapped thru the sprue, as in ordinary bench moulding, and a draw spike used for lifting the pattern from the drag.

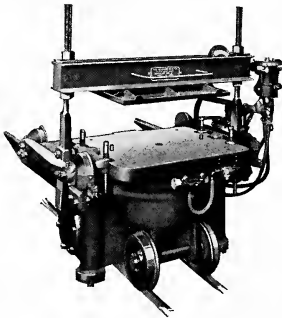

Fig. 113

Stripping Plate Patterns with Stools

There is also a system of squeezer-moulding used extensively among pipe fitters, and makers of other similar castings, which makes use of a pair of machines operating on one pattern. Such machines are called "split-pattern" squeezer-moulding machines. The only difference between this method and the match-plate method (which is used on the regular squeezer-moulding machine) is that two plates are used instead of one, i. e., the cope part of the pattern is mounted on one plate and the drag part of the pattern on another plate, the patterns of the two plates being so mounted as to properly align after the two halves of the mould have been set together.

The "split-pattern" type of squeezer-moulding machine is

also convenient for moulding that type of squeezer work requiring stools to aid in drawing the pattern from certain portions of the mould.

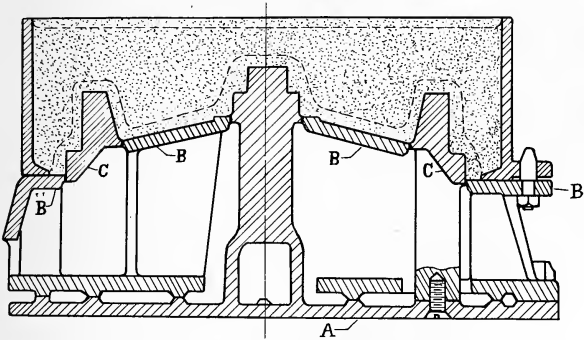

Fig. 114

In order to satisfactorily produce moulds by the jolt-ramming squeezer method—from patterns having pockets or depressions, and which likewise require a suspended body or bodies of sand to be held securely in place, while the pattern is being withdrawn from the sand—it is necessary to stool the pockets or depressions of the pattern, i. e., the pendant sand is supported

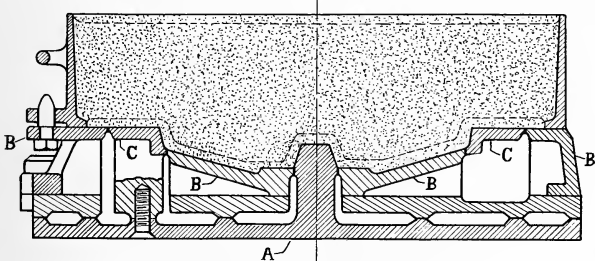

Fig. 115

while the flask with the mould is withdrawn from the pattern. This will be explained more fully in the following detailed description.

To illustrate this method of moulding, Figure 113 shows a jolt-squeeze and stripping-plate moulding machine, which is especially adapted to this particular type of work.

Figure 114 is a cross-section drawing of the drag of an automobile flywheel pattern, while Figure 115 shows a cross section of the cope pattern. It is obvious that the sand between the rim and the hub of the drag half of the mould, also the body of hanging sand in the cope, will require supports when stripping the pattern from the mould. The drag and cope patterns consist of sub-plates A, which are bolted and doweled to the jolt-table. Stripping-plate B, by means of which the flask is lifted or drawn from the pattern, and which rests on the sub-plate A, is elevated by means of pins at each end of the sub-plate, as well as the rim of the flywheel C; as the same principle is applied to both the cope and the drag moulds, it is necessary to describe only the drag part of the pattern. The sub-plate has a central projection extending upward and forming the hub of the flywheel, and the core print of the hub core.

The rim of the flywheel pattern consists of a ring with a multiple number of downward extending lugs, by means of which it is securely fastened to the sub-plate A; each leg extending thru the holes in the stripping-plate B.

The hub and rim of the pattern should be cast integral with or bolted to the sub-plate, and remain stationary while the stripping-plate B is being lifted, thus stripping or drawing the mould from the hub and rim. The pendant part of the mould is supported by stripping-plate B during this operation.

It will be noted that the stripping-plate lifts the flask and at the same time strips the hub of the pattern from around the center of the hub and the inside and the outside of the flywheel rim.

To produce good moulds and consequently sound castings, it is not only necessary to be able to strip this type of pattern, but also to make sure that the sand is securely held in position by the stool plates, while the mould is being lifted from the stripping-plate. It is also necessary to provide a means to insure the sand being securely held while the mould is carried and

placed on the pouring floor; this is accomplished by casting ribs on the flask, as shown by the dotted lines in Figures 114 and 115. The section of these ribs should be tapered, the point next to the pattern decreasing to a size about $\frac{1}{8}$ " and as close to the pattern as will permit a uniform ramming of the sand over the entire surface of the patterns. The distance between these ribs and the pattern should not be more than $\frac{1}{2}$ ". It is important that the ribs referred to be substantial, so as to avoid vibration which would destroy the mould while being jolt-rammed.

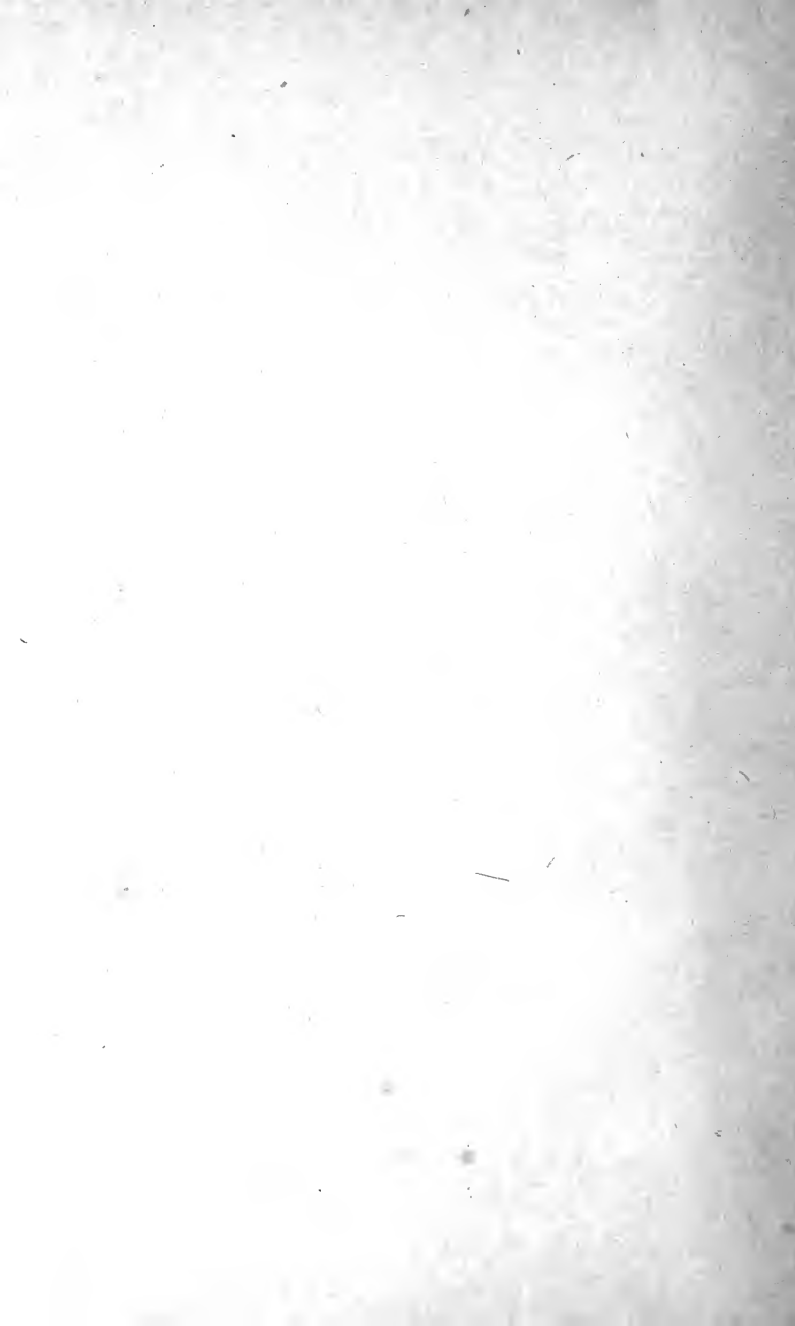

CHAPTER IX

Machine Moulded Cores.

The exceptional demand of the automobile industry for castings, in addition to forcing the use of a method of moulding that was speedier than the method in use a few years ago, also made necessary a way in which to produce the tremendous quantities of dry-sand cores that were required for the production necessary to meet the demand.

There are a number of different styles of moulding machines that are used to advantage in the core-room. There are also a number of the smaller cores that can be made by hand on the bench faster than when made on moulding machines. Therefore, it is the large, yet delicate and intricate core with which this chapter will deal.

The subject of core-making is one of such magnitude that the little given in this chapter appears insignificant; it is with a keen realization of this fact that the author ventures to show and describe a few of the core-making operations, attempting only to create in the minds of those who are not familiar with the highly developed state of the art, a desire to know more of the possibilities awaiting the introduction of the moulding machine into the core-room. Therefore, with this explanation the reader is requested to refer to Figure 116, which illustrates several complicated cores that have been produced on the moulding machine. By careful study of the view, it will be seen that some of these cores are made in one piece, while others are views of several cores assembled together.

Gauging and Inspection of Dry Sand Cores

Foundries producing high grade castings have adopted a rigid system of core-inspection by which the various individual cores are measured by gauges, having the allowable limits.

In addition to the gauging and inspecting of the individual core, extreme accuracy is required in the setting, and there-

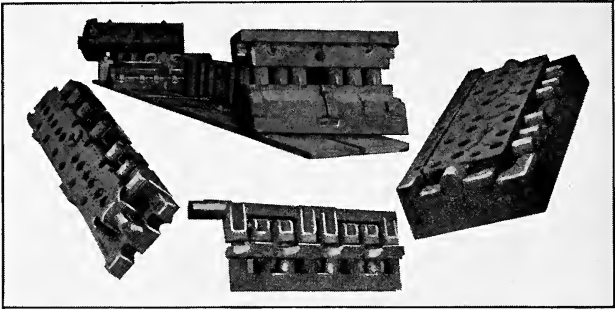

Fig. 116

fore, to insure the core being accurately set, there has been devised a system of assembly jigs in which the detail cores are made fast into the composite core assembly, and held firmly in place by pouring lead into the interlocking holes provided in the different detail cores.



Fig. 117

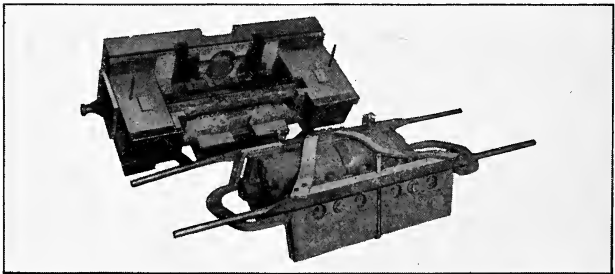

Fig. 118

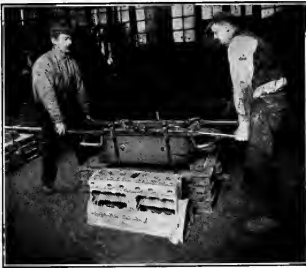

Fig. 119

ordinary manner, still failed to meet the requirements, as it was found that sufficient accuracy could not be attained, because of variation, due to core straining the core-print pockets, when being lowered into the mould. This condition was overcome by providing suitable core-setting jigs, as illustrated in Figures 118 and 119. Figure 118 shows in the background an assembly jig and in the foreground the assembled core attached to the setting jig. Figure 119 shows the manner in which the jig is used while lowering the core into the finished drag-mould. It will be seen from this view that the core-setting jig is guided to place by means of the flask pins. The style of casting which

this mould will turn out is shown in the foreground.

The cores illustrated in the previous views were made on the moulding machine illus-

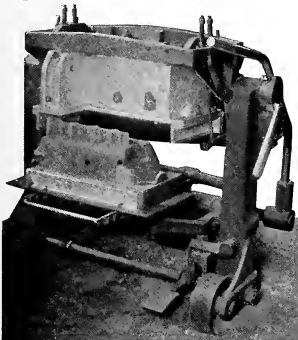

Fig. 120

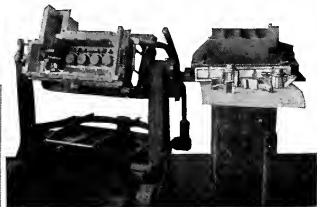

Fig. 121



Fig. 122

trated in Figures 120 and 121. From Figure 120 it will be seen that the core has been rammed on the machine and then rolled over and the patterns and loose pieces drawn from the main core-box. Figure 121 shows the same core after it has been lifted to the side of the machine, the loose pieces withdrawn and the core-box partly rolled back in order that the complicated

core-box may be seen to advantage.

Dry-sand piston cores are produced at the rate of six per operation on the machine shown in Figure 123; while in Figure 124 the producing of piston moulds is shown, using the green-sand core method instead of the dry-sand.

Green Sand Cores

Fig. 124 shows a mould for the making of grey iron castings for gas engine pistons. This is a good example of green sand cores, as they are made on a moulding machine. The cores are formed integral with the drag portion of the mould in a metal core-box, so arranged as to produce four cores at one cycle of operation. This core-box is of the split type, and is parted directly through the centers of the cores. The wrist-pin bosses are secured to the inside of the box on a center

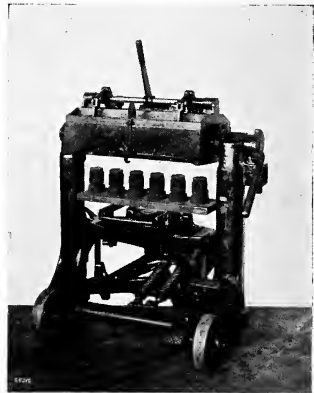

Fig. 123

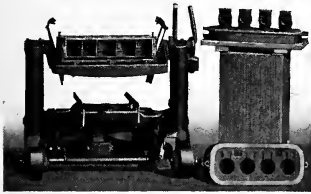

Fig. 124

line at a right angle to the parting line of the box. The top of the box forms a flat surface of sufficient area to form the parting line of the mould. The members of the core-box are arranged to be separated in a horizontal plane, by means of a lever located at the back of the box, so as not to interfere with the movements of the operator. Tongues are provided on the ends of the core-box members which slide in grooves in the upright ends of the frame. A bearing strip provided at the bottom of the box prevents the distortion of the box while being rammed. This core-box was mounted on a Roll-Over Moulding Machine and was used in the following manner: with the core-box set in the position shown in the illustration, the drag flask was placed on the core-box with the pins on the core-box properly engaging the holes in the flask ears. The core-box was then filled with riddled moulding sand and the sand tamped and packed on the lower side of the wrist-pin bosses, after which the flask was filled and rammed complete. The mould was then "struck off," the bottom board clamped in place, and the table carrying the core-box rolled over. The leveling bars were then brought up against the bottom board and the automatic leveling pins locked. The bottom board clamps were next released, after which the vibrator was started and the members of the core-box drawn apart by means of the lever provided for the purpose. The flask and cores were then lowered to clear the core-box and removed from the machine to the position shown in illustration.

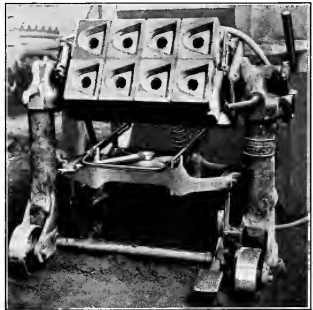

Fig. 125

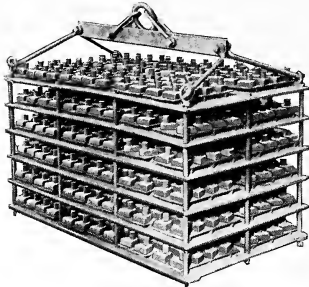

Fig. 126

125, which required an operation of four hours per day to produce the rack of cores shown in Figure 126. In the core-room in the average foundry producing general castings very little attention has been given to the possibilities of producing cores on moulding machines; yet this vast field of possibilities is awaiting the foundryman who will follow the lead of those now beginning to realize that it is not enough to make the saving possible on the moulding floor, but that it should be carried into the production of the core-room.

Figure 127 illustrates at a glance the readiness with which a core-box can be mounted on a machine. In fact, the operation of mounting a core-box on a moulding machine is a simple one, compared to that of mounting the patterns on plates for machine work, as with the core-box the only requirement is to provide the necessary bolts with which it is bolted to the machine table. The machine shown in this view is the Roll-Over Jolt type of moulding machine, which jolt-rams the core, rolls it over and draws the box from the core by power, leaving it on the drier plate. On the run-out car may be seen the core that was produced in the box shown mounted on the machine.

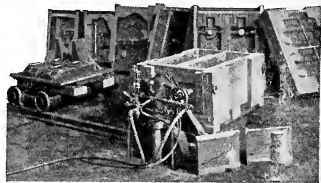

Fig. 127

Tunnel Segment Cores

The tunnel segment casting, fully illustrated and described in Chapter II, pages 12 and 13, required a large number of cores to produce the bolt-holes in each side of the casting. To meet this situation, eight core-boxes were mounted on the moulding machine shown in Figure

CHAPTER X

Flask Equipment.

Of exceptional importance to the successful operation of moulding machines is the providing of suitable flasks. It is a waste of time and money to attempt the production of good moulds on moulding machines without giving the proper consideration to flask equipment. Every foundryman is familiar with the difficulties encountered with the ordinary flask equipment in use in the foundries producing moulds by hand-ramming methods, and the loss occasioned by the use of flasks that are burnt, or have become loosened by the severe handling incident to foundry practice. Flasks in this condition should not be used, even in hand-moulding, and the time consumed in additional care, as well as the loss occasioned by their use, would more than offset the loss incurred by scrapping the old flasks and making new ones. Those foundries that are accustomed to the use of wood flasks only, find it rather difficult to immediately see the necessity of changing their viewpoint to coincide with modern founding. It had been their practice to roughly nail together a set of flasks for most every pattern that was to be used, thinking that the cost of wood flasks was small when compared with iron flasks. No attention was given, nor any attempt made, to standardize the flask equipment in order to reduce to a minimum the stock of flasks necessary to carry on the foundry operations.

The introduction of moulding machines has made possible the standardization of flasks in such a manner as to reduce the cost of flask equipment below that of the old style methods, so that a better and more durable flask can be made. Such flasks, when made of iron and given the proper consideration in handling, are practically indestructible and, therefore, in the end, are the most economical that can be made.

The subject of flask equipment is vitally important in order to bring the foundrymen, inexperienced in foundry moulding-machine operation, to a full appreciation and realization of the

place it occupies in producing moulds by machine methods; and therefore, the following views are shown to illustrate the styles of flasks that are largely in use for moulding machine production.

Snap Flasks

As a large amount of the work produced on air-operated squeezer-machines is made in snap-flasks, Figs. 128, 129, 130 and



Fig. 128

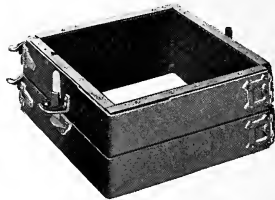

Fig. 129.

131 are shown to illustrate the different styles in common use on those machines.

The manner in which these flasks are used is clearly set forth in the descriptive matter, as well as illustrated in the different photographs of Chapters VII and VIII.



Fig. 130

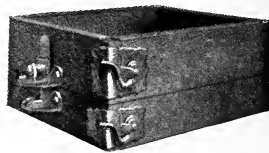

Fig. 131

There is some work of such size and shape as to be readily adapted to squeezer-moulding and yet, because of its weight, it cannot be successfully made in snap-flasks. Such work is usually made in iron flasks of very light construction, as illustrated in Fig. 132.

The flask shown in Figure 133 illustrates one in common use in the aluminum and brass foundry industry.

What has been said of the above flasks and their adaptation to air-squeezer moulding, can also be said of their use on the hand-rammed roll-over type of machine, on such work as does not readily lend itself to squeezer-moulding.

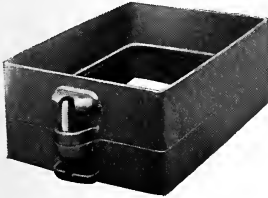

Fig. 132

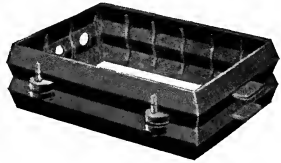

Fig. 133

Cast Iron Flasks and Bottom Plates

The several preceding chapters have pointed out the importance of the flask equipment used on the Plain and Roll-Over Jolt type of moulding machines, and, therefore, the following views are used to show the details of flask construction that are recommended for use on the machines that have been described.

The complete flask illustrated in Figure 134 is used in connection with the Roll-Over Jolt-Moulding Machine. In this view may be seen the type of closing-pin used, which has proved to be the best all around type of pin.

The use of this particular type of closing-pin prevents the breakage due to the old style method of fastening the pin in the drag half of the mould, while the flasks are being shaken out and handled in the foundry and storage yard.

It will also be noted in Figure 135, which shows the cope half of this flask, that the bars are secured by means of bolts, in order that the flask



Fig. 134

may be used on varying shapes and sizes. To facilitate the changing of the bars there are cast in the walls of the flask a row of holes which, in addition to their being used for bolts, are desirable for "letting off" the gases from the mould.

Figure 136 shows the drag half of this same flask which, in this particular case, requires the use of three special bars con-

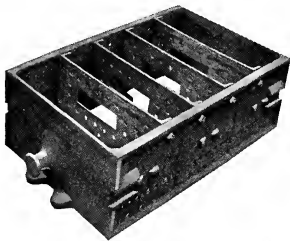

Fig. 135

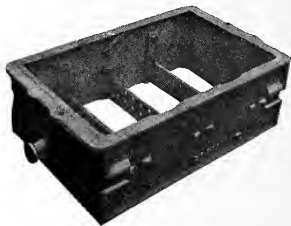

Fig. 136

nected as shown. The dovetailed slot shown at either end of these flasks makes possible the use of cast handle bars for handling the empty flask when the crane is not available.

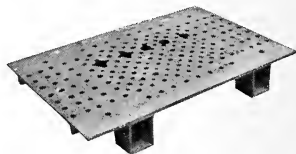

Fig. 137

Figure 137 shows the type of bottom board that is used with this type of flask. The bottom board may be either plain or supplied with projections, as here shown. The advantages of the projections are many, inasmuch as it is more convenient to release the chains when carrying the mould to the foundry floor, as well as for attaching the chains after the mould has been poured and ready to be taken to the "shake-out" floor; while the cost of providing the plates with the projections referred to is greater than that of producing the flat plate, nevertheless, when it is considered that the plate is to be used continually, it is well to ascertain whether or not the time saved in crane service does not far exceed the additional expense of providing the extra projections on the plates.

On smaller moulds, however, which are of a size that can be carried away by hand, without the use of a crane, an inexpensive bottom board is made by the use of cast iron or steel plates with standard channel-iron riveted to their back, as is shown in Figure 141.

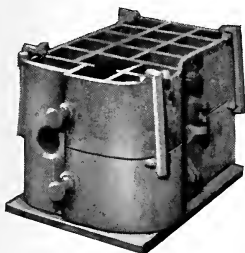

Fig. 138



Fig. 139

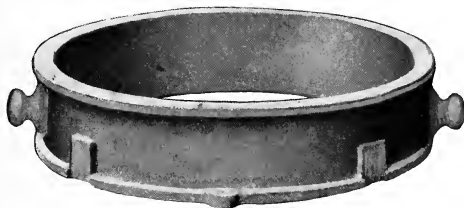

Fig. 140

Cut Flasks

The amount of sand to be handled in a day's production is one of importance to the foundryman producing the largest quantity of castings, and careful consideration must be given to the size and shape of his flask, in order to reduce to a minimum the amount of sand to be handled.

The agricultural and stove plants have developed the "cut-flask" in a most remarkable manner, as the years of experience in producing agricultural and stove castings by the hand method fully demonstrated the lack of wisdom in handling the great amount of sand necessary in the rectangular-shaped flask. These

plants have also used a minimum amount of sand between the profile of the mould and the flask which, of course, is made possible only by the fact that the flasks which they use are of the highest type of design and of exceptionally light and rigid construction.

Illustrations of flasks shaped to the outline of the pattern are shown in Figure 138, while the flasks shown in Figures 139 and 140 are further illustrations of flasks that have been made round in order to reduce to a minimum the amount of sand to be handled.



Fig. 141

Rolled Steel Flasks

The descriptions thus far have covered flasks that are to be made from castings, either gray iron or aluminum. There has been, however, a flask developed which in many respects, on



Fig. 142

certain sizes of flasks, is better than those made by casting. This particular flask, shown in Figures 142 and 143, is made from steel, the section of the flask being designed especially for producing rigidity by means of ribs which are rolled into the plate.

The manufacturers, realizing that there would be a large demand for a light and rigid flask, have provided special rolls to produce the various shapes required. The shapes are rolled in long bars and in the manufacture are shaped by the use of a large bending apparatus to the desired size; the joint is then firmly riveted.

By referring to the illustration of these flasks, it will be seen that there are light malleable castings provided for carrying the flask pins as well as a light section handle casting riveted to the corners.



Fig. 143

Mention has been made of the importance of the proper flask equipment. It is not too much to again emphasize the fact that without the proper pattern and flask equipment, machine-

moulding is practically an impossibility, and yet it is not desired to convey the impression that the providing of the proper patterns and flask equipment is a difficult task. The fact of the matter is that the proper equipment can be provided with very little, if any, additional cost over that for producing the usual equipment required for floor moulding.

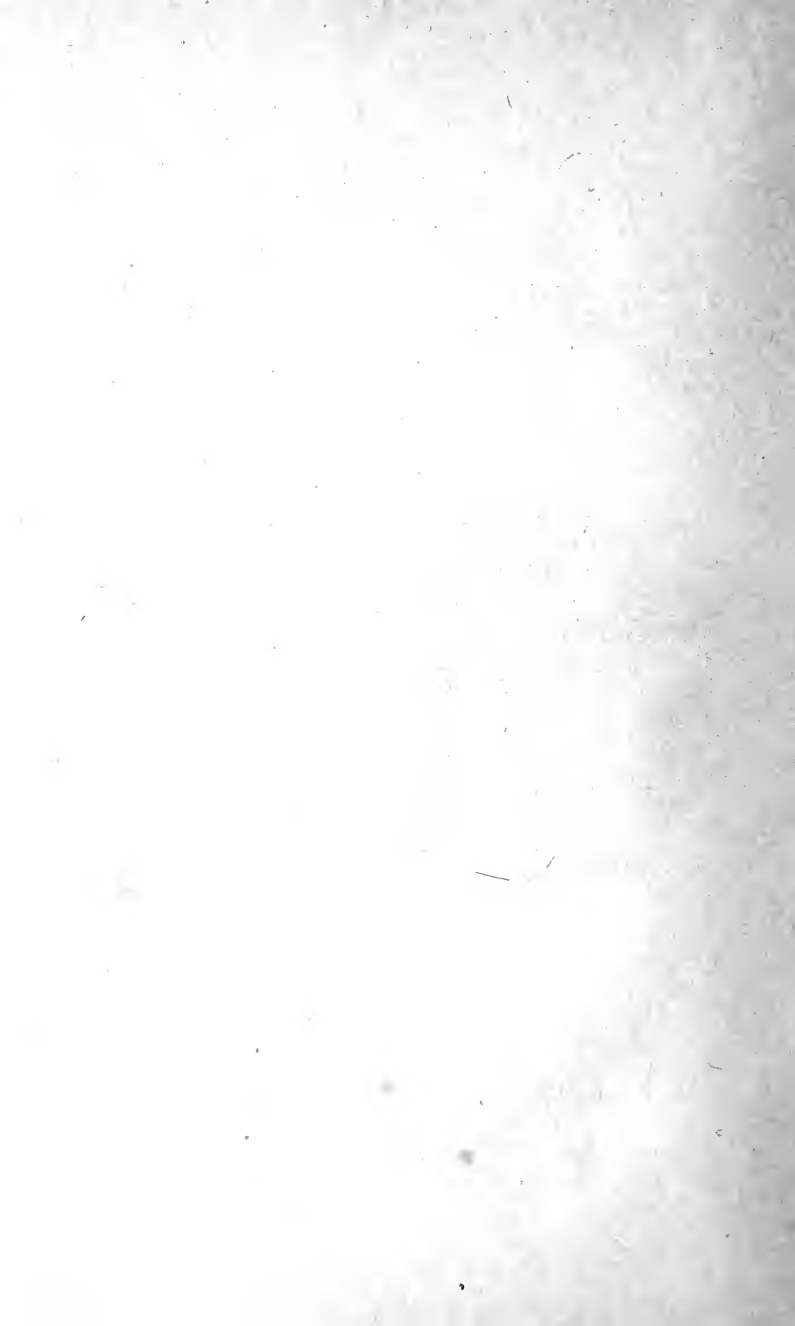

CHAPTER XI

Foundations for Jolt-Ramming Moulding Machines

In order to intelligently consider the proper foundations for modern jolt-ramming machines, it is necessary to review briefly some of the machines of earlier types. In many instances it was considered necessary, to effectively jolt-ram a mold, to

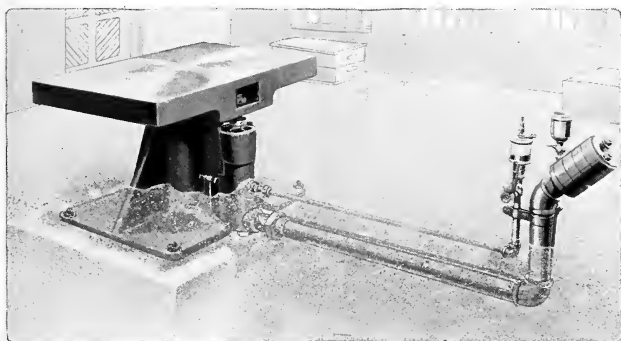

Fig. 144. Plain Jolt-Ramming Moulding Machine with only Sufficient Foundation to hold the Machine in place. The Sand may be filled around the Machine as the working parts are protected.

have a machine that would produce a heavy blow. This usually was accomplished by building the machine with a stroke of 3 to 4 or even 6 inches in length. This stroke, of course, would produce the heavy blow, its action was not unlike the blow of a steam hammer.

In order to control the ground vibrations produced by such a machine, it was necessary to provide massive foundations, and in many instances the concrete was capped with several layers of wood to aid in the absorption of the blow.

The recent rapid development of jolt-ramming machines has practically reversed the early theory of design, as it has been determined that it is not the force of the machine blow that packs the sand, but that it is packed by the jolting table being suddenly or abruptly brought to rest while the sand in the flask to be packed continues its downward course, thereby producing the pressure which results in the sand packing against the pattern or pattern-plate. It is quite evident, therefore, that

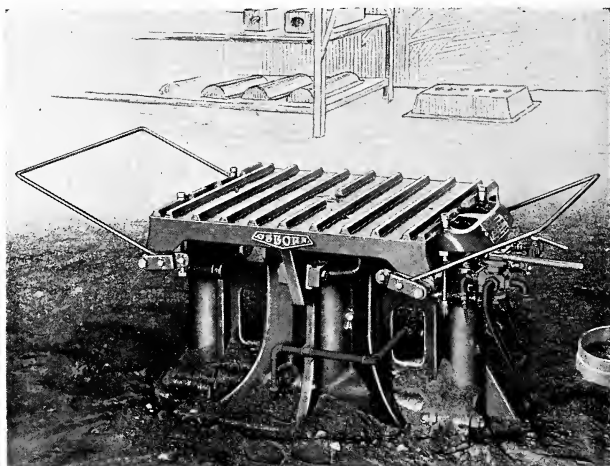

Fig. 145. Foundry Floor View of Jolt-Ramming Power-Stripping Moulding Machine with Working Parts Protected.

if the machine which has been brought suddenly to rest be instantly started again on its upward stroke and not allowed to pause, an increased pressure of the pattern against the sand will result, which causes the sand to lay and not rebound.

A jolting machine necessary to accomplish this need not be unduly massive in its working parts, nor need it have a long stroke, 1 to 2 inches usually being sufficient. It should have means of controlling the force of the blow of the table

when contacting with the anvil base, as it is evident that the weight of the moving table (or dead load) must not be allowed to freely drop and contact with the anvil block, or it will produce the unnecessary heavy blow. The up-to-date, modern jolting machine prevents this heavy blow by providing

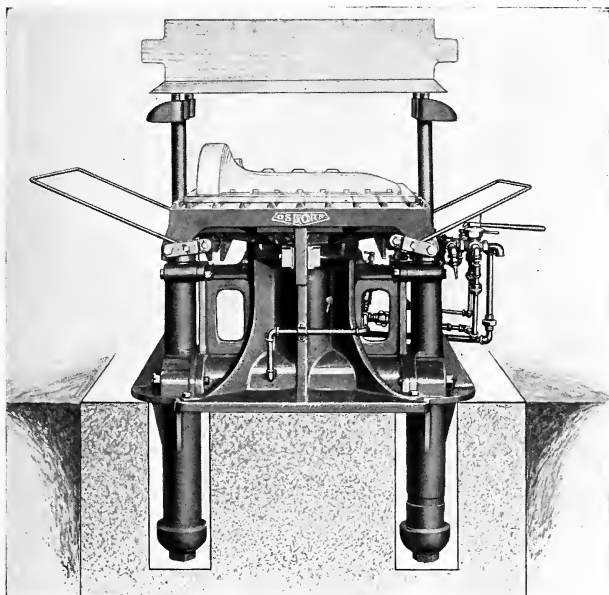

Fig. 146. Same Machine as Fig. 145, showing Simplicity of Foundation.

an air cushion under the cylinder sufficient to overcome the violent blow caused by the dead load, allowing only sufficient blow to accomplish the instant reversal of stroke.

A machine that accomplishes the foregoing not only will ram a good mould in a very short time, but will do so without excessive or detrimental vibration in either the machine, pattern or foundation.

As we now approach our subject—the machine foundation—it is evident that with such a machine the extremely massive foundation is not essential and, therefore, our consideration will be from the standpoint of economy and accessibility.

Of first importance is the kind and nature of the soil upon which the machine foundation is to be placed. A dry gravel is considered the thing next best to solid rock and will safely stand a load of 6,000 to 8,000 pounds per square foot. Dry sand or

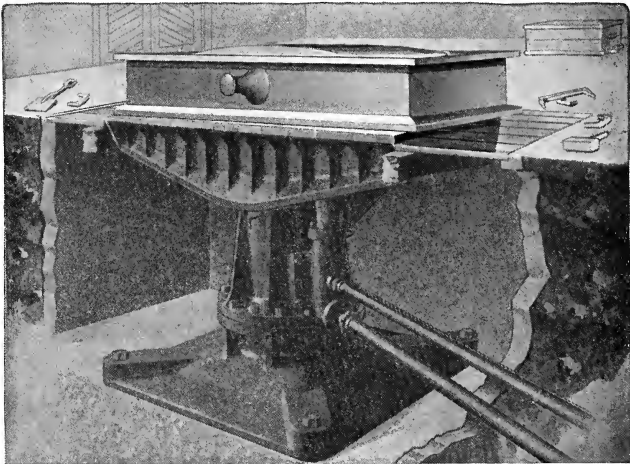

Fig. 147. A Large, 42 x 97-inch, Plain Jolt-Ramming Moulding Machine, showing Section through Foundation and Pit.

dry sand and gravel mixed makes a very good foundation base and will withstand a load of 4,000 to 8,000 pounds per square foot. Clay soils vary widely; a soft clay will flow in all directions even under very light load, and should not be loaded more than 3,000 pounds per square foot, while a dry clay will satisfactorily stand a load of 3,000 to 5,000 pounds per square foot. If the foundation is to be placed on *made* ground or *fill*, provision should be made to keep the ground perfectly dry and free from

water. With the proper condition existing a satisfactory foundation can be made, such condition being more desirable than a wet or oozy clay soil. When the foundation is placed on *clay* or *fill*, better results can be obtained by having it cover a large area rather than making it of greater depth, unless the fill is of such depth that the foundation may be extended through to solid soil.

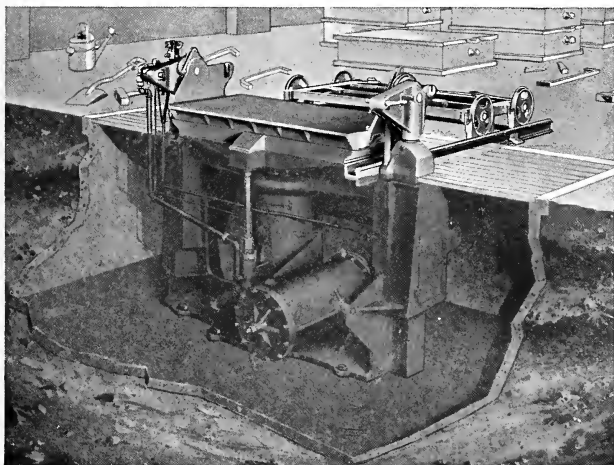

Fig. 148. A 64-inch Roll-Over Jolt-Moulding Machine, showing Section through Foundation.

It must be remembered that when we place a moulding machine in the foundry we are actually violating the old established principle of machine installation and *placing it in a sand pile* instead of an engine room, or other dirt and dust-proof room, and yet notwithstanding this extraordinary condition, and without giving the machine proper care, many foundrymen expect as good results from the machine in the sand pile as they do from the machine that was placed in a dust-proof room and in charge of an expert mechanic.

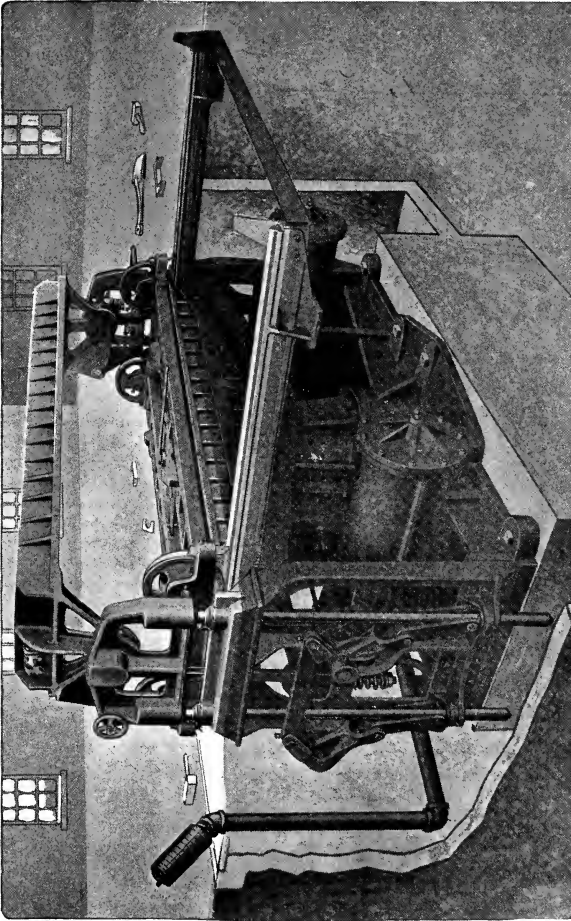

Fig. 149. Same Machine as Fig. 151, showing Section through Foundation.
The Machine is set on a Pier in order to obtain head room in the Pit.

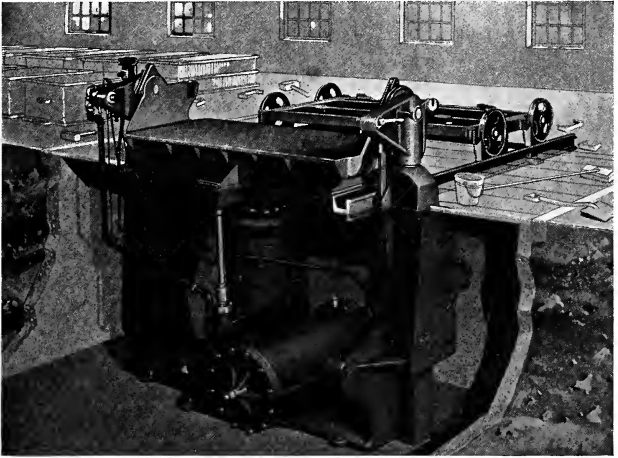

Fig. 150. View of Large, 42 x 109-inch Roll-Over Jolt-Moulding Machine.

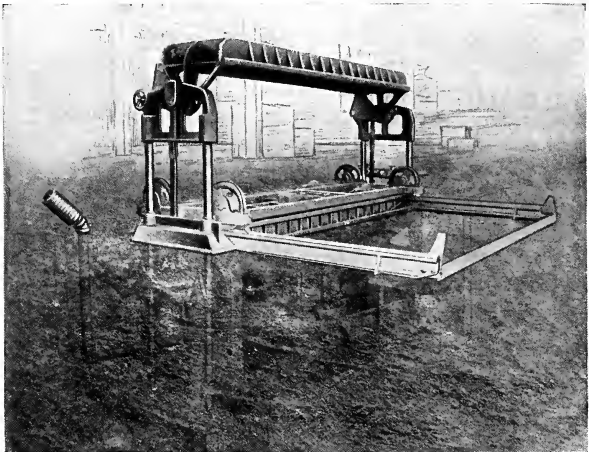

Fig. 151. A 36 x 150-inch Roll-Over Jolt-Moulding Machine, Base and Foundation shown in Phantom as it appears above foundry floor.

The accompanying illustrations will demonstrate that it is economy to provide a foundation and setting that will give ample protection to the machine, by making it impossible for



Fig. 152. Foundry Floor View of 42-inch Electrically Operated Roll-Over Jolt-Moulding Machine, showing Foundations in Phantom.

sand to collect on the machine or in its moving parts. They also will show the advisability of providing ample space around the machine so that the mechanic can easily oil, inspect and keep the working parts in order, the same as he does the machine placed in the engine room. The depth of the space surrounding

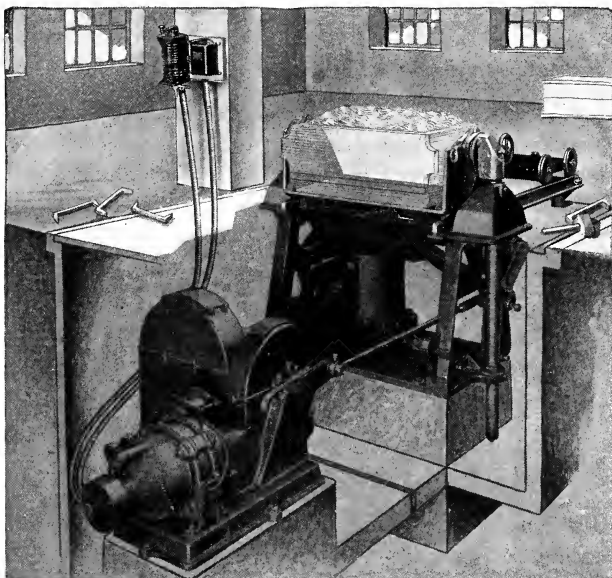

Fig. 153. Same Machine as Fig. 152, showing Section of Foundation

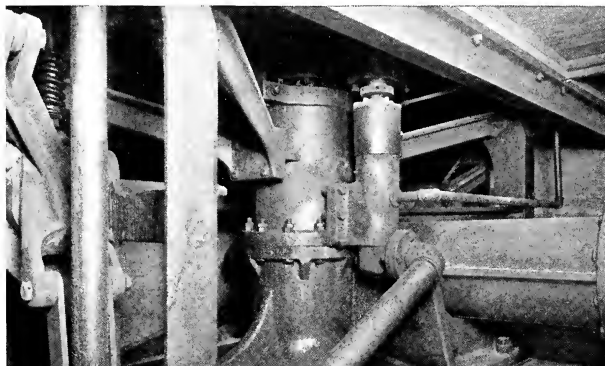

Fig. 154. This Photograph was taken in the Pit and shows the Excellent Condition of the Base of this Jolt-Ramming Moulding Machine and its Freedom from Sand, etc.

the machine should be sufficient for a man to stand erect, suitable lighting facilities should be provided and a stairway or ladder should lead into the pit.

The covering of the pit or foundry floor should be made of 2-inch matched planking and should be fitted tight against the



Fig. 155—Entrance Way into the Foundation Pit of a Jolt-Moulding Machine, showing Steps leading into the Pit from an Adjoining Basement Room.

machine. The trap door leading into the pit should be hinged and of ample size.

The engineer or architect called upon to design and build the foundry of tomorrow will do well to thoroughly consider the best method of installing and maintaining the moulding machines to be used, placing them in such manner as to insure ample protection from dust and grit and making it easy to give the machines the care and attention they deserve.

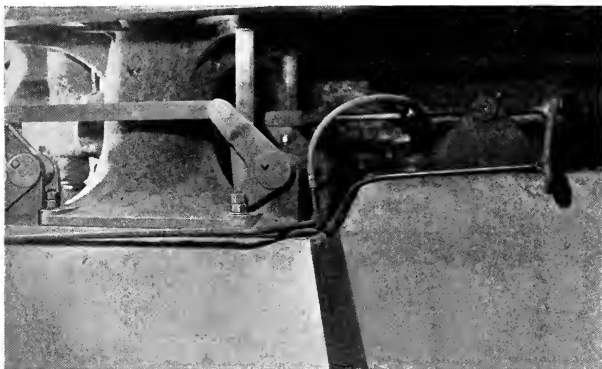

Fig. 156. View of Jolt-Ramming Moulding Machine, taken in the Pit, showing Construction of the Pier.

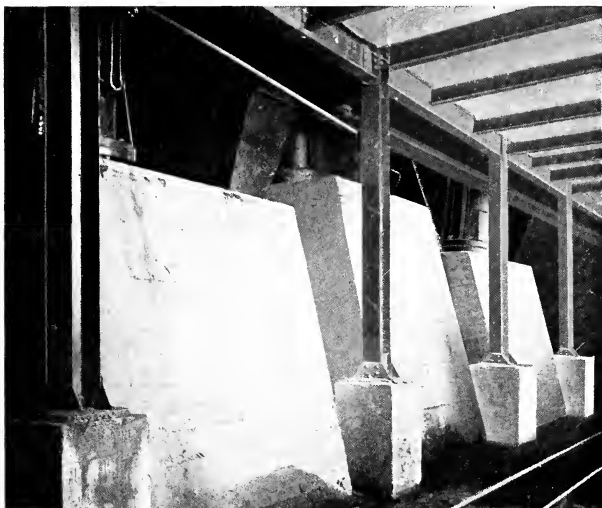

Fig. 157. View showing Several Jolt-Ramming Moulding Machine Foundations with Piers built on the Basement Floor.

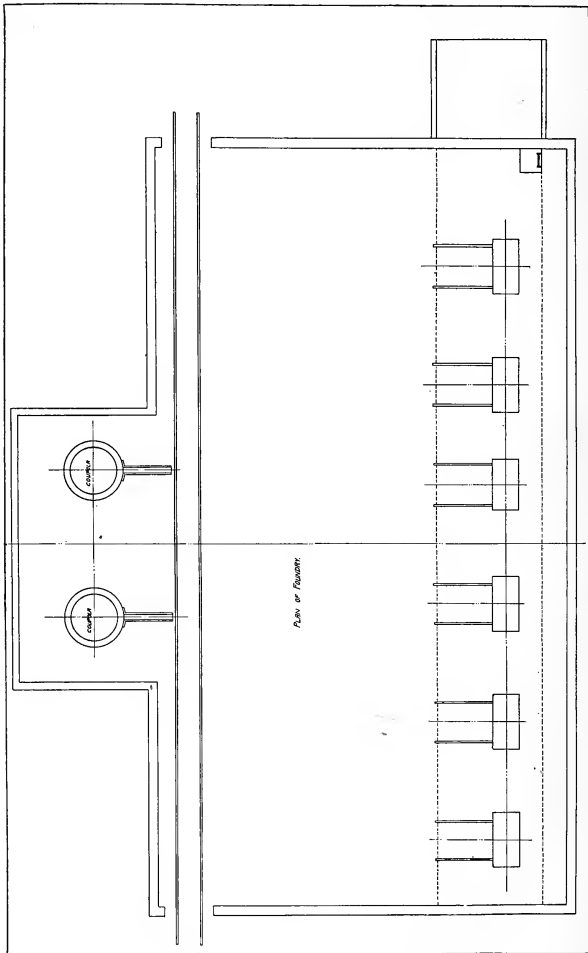

Fig. 158. Plan View of a Proposed Foundry having a Tunnel or Basement for Setting Machines.

The author's idea of a foundry that will best meet these requirements is set forth in Figs. 158 and 159. These illustrations show the plan and cross-section of a proposed foundry, having a tunnel or basement extending the full length of the moulding

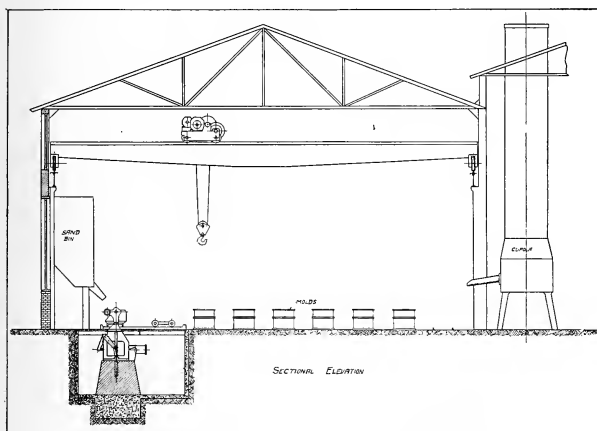

Fig. 159. Cross-Section of the Proposed Foundry, showing Tunnel for Machine Foundations.

floor. The floor of this tunnel or basement should be at least 7 feet below the ceiling and the width should be sufficient to allow a clear passageway on one side of the machines; the piers for the machine foundations can be placed at any time and to suit any condition.





LIBRARY OF CONGRESS



0 016 066 085 5 ●